

**Petite  
Friture**

COLLECTION  
2024

PETITE FRITURE HAS MADE A NAME FOR ITSELF AS A DESIGN EDITOR LIKE NO OTHER, A UNIVERSE TO LIVE IN WITH A WHOLLY INDEPENDANT STYLE AND TONE.

PETITE FRITURE IS AN EXPRESSION OF UNIQUE ENCOUNTERS, INTUITION, AND REVELATIONS. CHALLENGE NORMS. QUESTION THE OBVIOUS. TAKE THE PATH LESS TRODDEN. CURATE TO ACHIEVE FULFILMENT FOR OURSELVES AND OTHERS. ON THE CUSP OF AUDACITY AND MODERNITY.

EACH ENCOUNTER IS A FIRST STEP ON A NEW JOURNEY. EACH PROJECT IS A CHALLENGE TO OVERCOME FOR TALENTED DESIGNERS AND CREATORS, UNITED BY THE DEMANDS OF SUCCESS AND A SHARED UNDERSTANDING OF BEAUTY.

SINCE 2010. THEIR COLLABORATIVE EFFERVESCENCE HAS SEEN PETITE FRITURE CREATE ICONIC PIECES LIKE CONSTANCE GUISSSET'S FEATHER-LIGHT VERTIGO SUSPENSION, THE OUTDOOR FURNITURE LINE WEEK-END WITH STUDIO BRICHET&ZIEGLER, AND MANY OTHER PIECES WITH UP-AND-COMING DESIGNERS AND WELL-RESPECTED STUDIOS ALIKE.

PETITE FRITURE IS PROUD TO TAKE A STAND, TO SEEK OUT THE BEST SOLUTIONS AT EVERY STEP OF THE WAY, TO USE THE RIGHT TECHNIQUES AND RIGHT PEOPLE TO BETTER SERVE THE PLANET AND DO SOMETHING GOOD. FROM AN EFFERVESCENT BLEND COMES A SENSE OF DRIVE, A DESIRE TO WORK TOWARDS SOMETHING SINCERE.

TRANSPARENCY, RESPECT, DIALOGUE - OUR BRAND IS ONE THAT SEEKS A SUSTAINABLE FUTURE FOR DECADES TO COME. ITS AMBITION IS TO CREATE VIRTUOUS BEAUTY THAT WILL LAST FOR MANY YEARS TO COME. IN 2023. PETITE FRITURE BECAME A PURPOSE-DRIVEN COMPANY. OUR MISSION: CONTRIBUTE, THROUGH OUR COLLECTIONS, TO MAKING GOOD OUT OF BEAUTY.

LIGHTING



VERTIGO NOVA  
CONSTANCE GUISET



VERTIGO 110 CM  
CONSTANCE GUISET



VERTIGO 140 CM  
CONSTANCE GUISET



VERTIGO 200 CM  
CONSTANCE GUISET



UNSEEN  
STUDIOPEPE



MÉTERRANÉA  
NOÉ DUCHAUFOUR - LAWRENCE

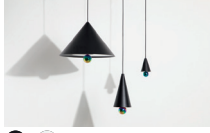

CHERRY  
DANIEL + EMMA



CHERRY 5  
DANIEL + EMMA



QUASAR  
SAMY RIO



NEOTENIC  
JUMBO



TIDELIGHT  
PIERRE FAVRESSE

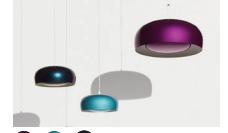

BRUSH  
PIERRE CHARRIÉ

FURNITURE



FRANCIS TABLE  
CONSTANCE GUISET



FRANCIS MIRROR  
CONSTANCE GUISET



FRANCIS MIRROR XL  
CONSTANCE GUISET



WANDER  
AC/AL



FROMME  
TOM CHUNG



FROMME WOOD  
TOM CHUNG



FROMME WOOD  
TOM CHUNG



FROMME WOOD  
TOM CHUNG

LEATHER



LILY  
FÄRG & BLANCHE



GRID  
POOL



HOFF  
MORTEN & JONAS



HOFF  
MORTEN & JONAS



HOFF  
MORTEN & JONAS

OUTDOOR



WEEK-END  
STUDIO BRICHTZIEGLER

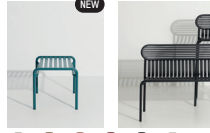

BUBBLE  
VAULOT & DYÈVRE



DONUT  
PIA CHEVALIER



KLUMP  
HENRIK ØDEGAARD

WALLPAPER DECORATION

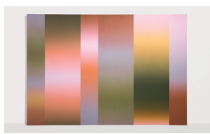

PANDRAMA WALLPAPER  
CAROLE BALJINGS



LARGE STRIPES WALLPAPER  
CAROLE BALJINGS

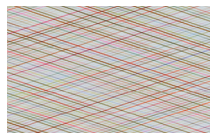

SMALL STRIPES WALLPAPER  
CAROLE BALJINGS



GAUFRETTE WALLPAPER  
LES CRAFTIES



CROISILLON WALLPAPER  
LES CRAFTIES



MOSAÏQUE WALLPAPER  
LES CRAFTIES

# Collections

01 LIGHTING P. 06

---

02 FURNITURE P. 32

---

03 UPHOLSTERY P. 49

---

04 OUTDOOR P. 73

---

05 DECORATION P. 87

---

**LIGHTING**



# BRUSH

PIERRE CHARRIÉ

2023



Violet



Light blue

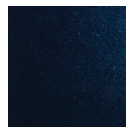

Beetle

## Pendant lamp

Materials

Aluminium

Colors

Violet, light blue and beetle

Origin

France & Italy



### TECHNICAL SPECIFICATIONS

EUROPE

UK



Power

220-240 V 50-60Hz

Power

220-240 V 50-60 Hz

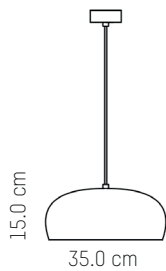

## 35.0 cm

-

**CE and UKCA canopy:** 9.0 cm | 3.5 inches

### CABLE LENGTH

**Electric cable:** 300.0 cm | 118.1 inches

**Wire:** 320.0 cm | 126.0 inches

**Ø:** 35.0 cm | 13.8 inches

**H:** 15.0 cm | 5.9 inches

**Weight:** 1.9 kg | 4.2 lb

### PACKAGING

**L:** 36.5 cm | 14.4 inches

**W:** 36.5 cm | 14.4 inches

**H:** 22.5 cm | 8.9 inches

**Weight:** 2.8 kg | 6.2 lb

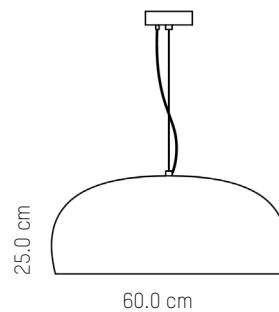

## 60 cm

-

**CE - UKCA canopy:** 12.0 cm | 4.7 inches

### CABLE LENGTH

**Electric cable:** 300.0 cm | 118.1 inches

**Wire:** 320.0 cm | 126.0 inches

**Ø:** 60.0 cm | 23.6 inches

**H:** 25.0 cm | 9.8 inches

**Weight:** 4.9 kg | 10.8 lb

### PACKAGING

**L:** 61.5 cm | 24.2 inches

**W:** 61.5 cm | 24.2 inches

**H:** 35.5 cm | 14.0 inches

**Weight:** 8.8 kg | 19.4 lb



## BRUSH

PIERRE CHARRIÉ

2023



Violet



Light blue

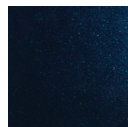

Beetle

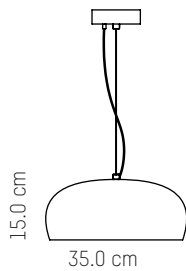

### 35.0 cm

-

**UL canopy:** 9.0 cm | 3.5 inches

#### CABLE LENGTH

**Electric cable:** 300.0 cm | 118.1 inches

**Wire:** 320.0 cm | 126.0 inches

**Ø:** 35.0 cm | 13.8 inches

**H:** 15.0 cm | 5.9 inches

**Weight:** 1.9 kg | 4.2 lb

#### PACKAGING

**L:** 36.5 cm | 14.4 inches

**W:** 36.5 cm | 14.4 inches

**H:** 22.5 cm | 8.9 inches

**Weight:** 2.8 kg | 6.2 lb

### Pendant lamp

-

**Materials**

Aluminium

**Colors**

Violet, light blue and beetle

**Origin**

France & Italy

TECHNICAL SPECIFICATIONS



US



**Power**

110-120V, 60Hz

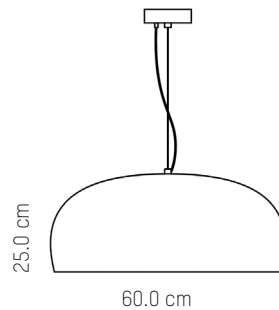

### 60 cm

-

**UL canopy:** 12.0 cm | 4.7 inches

#### CABLE LENGTH

**Electric cable:** 300.0 cm | 118.1 inches

**Wire:** 320.0 cm | 126.0 inches

**Ø:** 60.0 cm | 23.6 inches

**H:** 25.0 cm | 9.8 inches

**Weight:** 4.9 kg | 10.8 lb

#### PACKAGING

**L:** 61.5 cm | 24.2 inches

**W:** 61.5 cm | 24.2 inches

**H:** 35.5 cm | 14.0 inches

**Weight:** 8.8 kg | 19.4 lb

# NEOTENIC

JUMBO

2022



Cherry

Vanilla

Vermilion

Blue

## Table lamp

-

### Materials

Ceramic and glass.

### Colors

Cherry, Vanilla, Vermillon, Blue

### Origin

Portugal

### TECHNICAL SPECIFICATIONS



### LUMINOUS FLUX

250 lumens for the small

750 lumens for the large

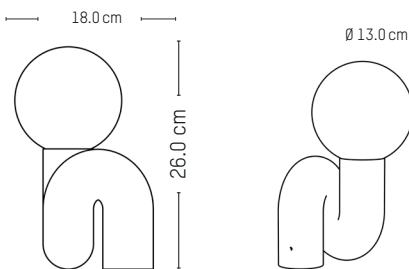

## Small

-

**L:** 18.0 cm | 6.9 inches  
**H:** 26.0 cm | 10.2 inches  
**Weight:** 1.6 kg | 3.5 lb

### PACKAGING:

**L:** 20.0 cm | 7.9 inches  
**W:** 18.0 cm | 7.1 inches  
**H:** 29.0 cm | 11.4 inches  
**Weight:** 2.0 kg | 4.4 lb

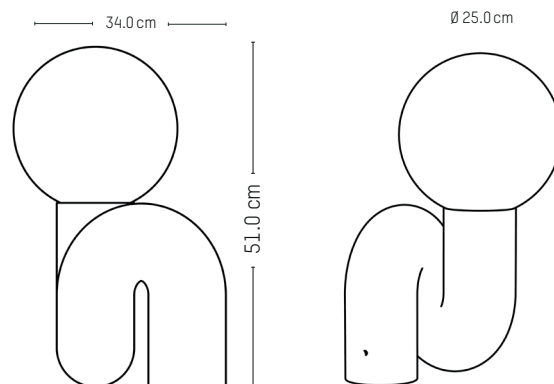

## Large

-

**L:** 34.0 cm | 13.4 inches  
**H:** 51.0 cm | 20.1 inches  
**Weight:** 6.6 kg | 14.6 lb

### PACKAGING:

**L:** 38.0 cm | 15.0 inches  
**W:** 36.0 cm | 14.2 inches  
**H:** 55.0 cm | 21.7 inches  
**Weight:** 8.0 kg | 17.6 lb

# QUASAR

SAMY RIO

2021 FIRST LAUNCH

WHILE STOCK LAST



Olive green



Black



Sienna



Emerald green

AVAILABLE FROM MAY 2024



Blue



Green



Grey



Purple

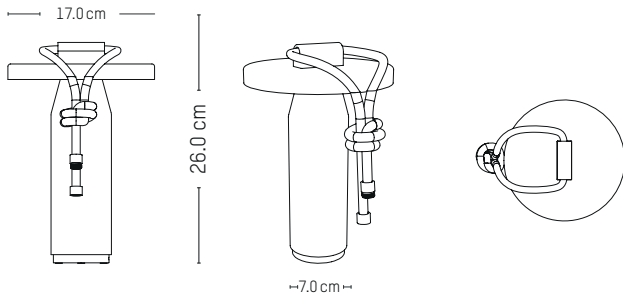

## Small

-

**ØTop:** 17.0 cm | 6.7 inches

**ØB:** 7.0 cm | 2.8 inches

**H:** 26.0 cm | 10.2 inches

**Weight:** 1.3 kg | 2.9 lb

PACKAGING:

**L:** 18.0 cm | 7.1 inches

**W:** 18.0 cm | 7.1 inches

**H:** 29.0 cm | 11.4 inches

**Weight:** 1.7 kg | 3.7 lb

## Portable lamp

-

Materials

Aluminium, PC, ABS and polyester.

Colors

While stock last : Olive green, Black, Sienna, Emerald green

From may 2024 : Blue, Green, Grey, Purple

Origin

China

### TECHNICAL SPECIFICATIONS



3 light intensities (100%, 50%, 25%)

Integrated LED

LUMINOUS FLUX

111. 137 or 149 lumens

# CHERRY

DANIEL ET EMMA

2021



Black and rainbow



White and gold

## Pendant lamp

### Materials

Aluminium, matt grained powder coating; mirror finish steel; disseminating fire resistant plexiglass; Fabric cable, white or black, 3m /118.1 inches; steel ceiling cup white or black ; Integrated LED

### Colors

Black and rainbow, white and gold

### Origin

France

### TECHNICAL SPECIFICATIONS

#### LUMINOUS FLUX

XS: 730 lumens. S and L: 1040 lumens

#### LED

XS - 5.5W  
S AND L - 7.8W



Integrated LED



EUROPE

UK

US



#### Power

220-240V, 50-60Hz

#### Power

220-240V, 50-60Hz

#### Power

110-120V, 60Hz

12

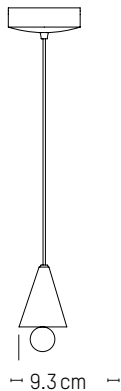

### XS-

D: 9.3 cm | 3.7 inches  
H: 17.0 cm | 6.7 inches  
Ø (sphere): 7.6 cm | 3.0 inches  
Canopy: Ø 15.0 cm | 5.9 inches  
Weight: 0.9 kg | 2.0 lb

#### PACKAGING:

Type: Carton box  
L: 19.6 cm | 7.7 inches  
W: 19.6 cm | 7.7 inches  
H: 24.4 cm | 9.6 inches  
Weight: 1.4 kg | 3.1 lb



### S

D: 16.0 cm | 6.3 inches  
H: 37.5 cm | 14.8 inches  
Ø (sphere): 7.6 cm | 3.0 inches  
Canopy: Ø 15.0 cm | 5.9 inches  
Weight: 1.2 kg | 2.7 lb

#### PACKAGING:

Type: Carton box  
L: 22.5 cm | 8.9 inches  
W: 22.0 cm | 8.7 inches  
H: 51.0 cm | 20.1 inches  
Weight: 1.8 kg | 4 lb

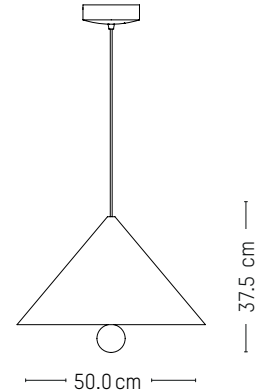

### L

D: 50.0 cm | 19.7 inches  
H: 37.5 cm | 14.8 inches  
Ø (sphere): 7.6 cm | 3.0 inches  
Canopy: Ø 15.0 cm | 5.9 inches  
Weight: 2.5 kg | 5.5 lb

#### PACKAGING:

Type: Carton box  
L: 58.5 cm | 23 inches  
W: 58.5 cm | 23 inches  
H: 51.0 cm | 20.1 inches  
Weight: 5.5 kg | 12.1 lb



# CHERRY

DANIEL ET EMMA

2021



White



Black

## Linear canopy configuration

### Materials

Steel, matt grained powder coating; Aluminium, matt grained powder coating; mirror finish steel; disseminating fire resistant plexiglass; Fabric cable, white or black, 3m /118.1 inches; steel ceiling cup white or black ; Integrated LED  
5 outputs for Cherry pendant light  
Mounting bracket system  
Plastic caps to hide non used outputs

### Colors

White, black

### Origin

France

2 POSSIBLE CONFIGURATIONS:

5 PCS XS CHERRY PENDANT OR 3 PCS S CHERRY PENDANT

## TECHNICAL SPECIFICATIONS

### LUMINOUS FLUX

3pcs: 3120 lumens  
5 pcs: 3650 lumens

### LED

3pcs: 5 x 5,5 W  
5 pcs: 3 x 7.8 W



Integrated LED



EUROPE

UK



### Power

220-240V, 50-60Hz

### Power

220-240V, 50-60Hz

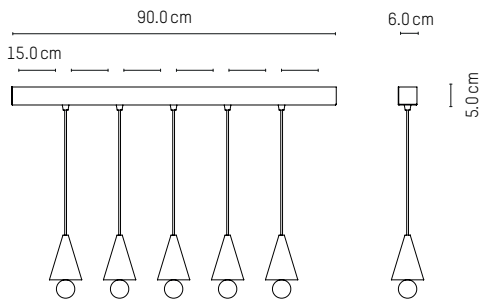

## Linear canopy

5 PCS XS CHERRY PENDANT

**L:** 90.0 cm | 35.4 inches  
**W:** 6.0 cm | 2.4 inches  
**H:** 5.0 cm | 2.0 inches  
**Weight:** 3.9 kg | 8.6 lb

PACKAGING:

**Type:** Carton box  
**L:** 90.5 cm | 35.6 inches  
**W:** 16.7 cm | 6.6 inches  
**H:** 27.0 cm | 10.6 inches  
**Weight:** 6.0 kg | 13.2 lb

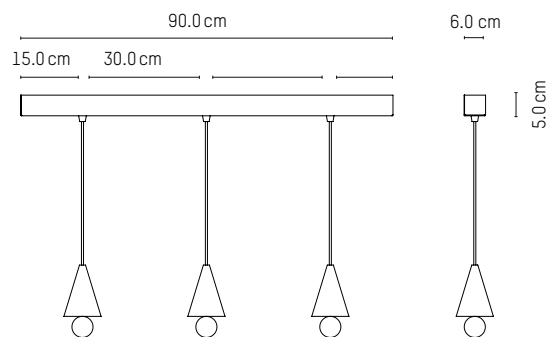

## Linear canopy

3 PCS S CHERRY PENDANT

**L:** 90.0 cm | 35.4 inches  
**W:** 6.0 cm | 2.4 inches  
**H:** 5.0 cm | 2.0 inches  
**Weight:** 3.4 kg | 7.5 lb

PACKAGING:

**Type:** Carton box  
**L:** 90.5 cm | 35.6 inches  
**W:** 16.7 cm | 6.6 inches  
**H:** 27.0 cm | 10.6 inches  
**Weight:** 5.5 kg | 12.1 lb

# CHERRY

DANIEL ET EMMA

2021



White



Black

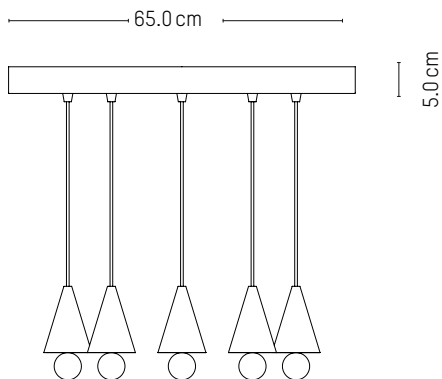

## Round canopy configuration

### Materials

Steel, matt grained powder coating; Aluminium, matt grained powder coating; mirror finish steel; disseminating fire resistant plexiglass; Fabric cable, white or black, 33m /118.1 inches; steel ceiling cup white or black ; Integrated LED  
5 outputs for Cherry pendant light  
Mounting bracket system  
Plastic caps to hide non used outputs

### Colors

White, black

### Origin

France

1 POSSIBLE CONFIGURATION:  
5 PCS XS CHERRY PENDANT

## TECHNICAL SPECIFICATIONS

### LUMINOUS FLUX

3650 lumens

### LED

5 x 5.5 W



Integrated LED



EUROPE

UK



### Power

220-240V, 50-60Hz

### Power

220-240V, 50-60Hz

## Round canopy

Ø: 65.0 cm | 25.6 inches

H: 5.0 cm | 2.0 inches

Weight: 5.9 kg | 13.0 lb

### PACKAGING:

Type: Carton box

L: 67.2 cm | 26.5 inches

W: 66.0 cm | 26 inches

H: 27.1 cm | 10.7 inches

Weight: 8.0 kg | 17.6 lb

# UNSEEN

STUDIOPEPE

2020



## Pendant lamps

-

### Materials

Smooth powder coated steel, varnished brass, polycarbonate tube

### Colors

Brass and translucent

### Origin

France

## TECHNICAL SPECIFICATIONS

Triple pendant

**LED**  
28W

LUMINOUS FLUX  
2410 lumens

Integrated LED

 EUROPE

 UK

 US







Power

220-240 V 50-60Hz

Power

220-240 V 50-60 Hz

Power

110-120 V 60 Hz







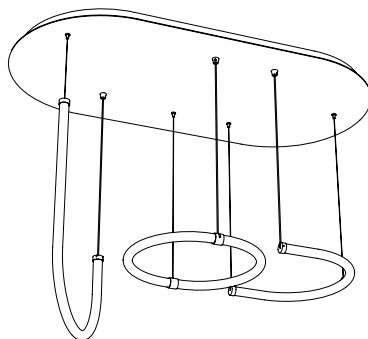

105.0 cm

## Triple pendant system

-

**L:** 105.0 cm | 41.3 inches

**W:** 53.0 cm | 20.9 inches

**H:** 58.0 cm | 22.88 inches

**Weight:** 15.0 kg | 33.1 lb

PACKAGING:

**L:** 115.0 cm | 45.3 inches

**W:** 86.7 cm | 34.1 inches

**H:** 58.0 cm | 22.8 inches

**Weight:** 17.0 kg | 37.5 lb

# UNSEEN

STUDIOPEPE

2020

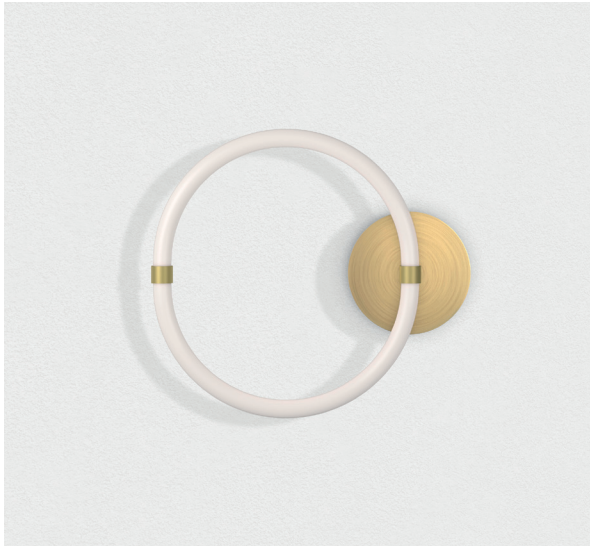

## Wall lamp

-

### Materials

Smooth powder coated steel, varnished brass, polycarbonate tube

### Colors

Brass and translucent

### Origin

France

### TECHNICAL SPECIFICATIONS



LED input:  
660 lumens



Integrated LED

EUROPE

UK

US



Power

220-240 V 50-60Hz

Power

220-240 V 50-60 Hz

Power

110-120 V 60 Hz

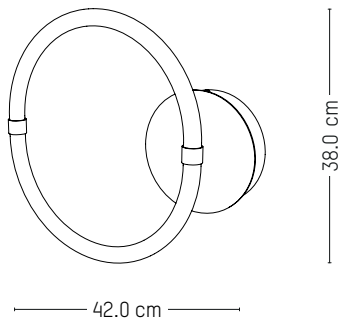

## Wall Lamp 0

-

**L:** 42.0 cm | 16.5 inches

**D:** 7.0 cm | 2.8 inches

**H:** 38.0 cm | 15.0 inches

**Weight:** 1.4 kg | 3.1 lb

### PACKAGING:

**L:** 46.7 cm | 18.4 inches

**W:** 42.7 cm | 16.8 inches

**H:** 6.8 cm | 2.7 inches

**Weight:** 3.0 kg | 6.6 lb



# UNSEEN

STUDIOPEPE

2020

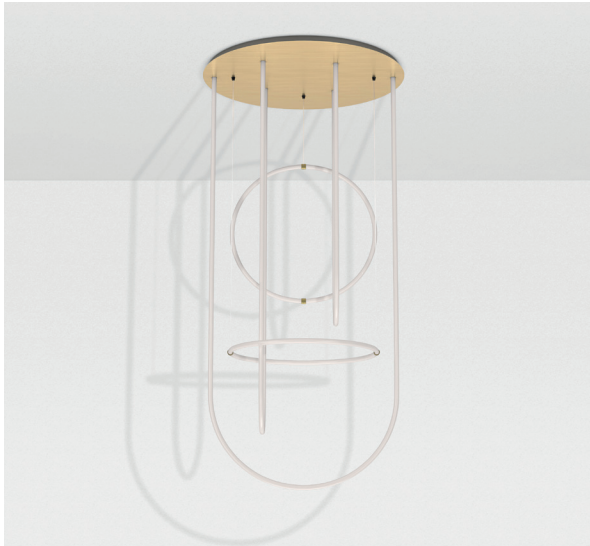

## Chandelier

### Materials

Smooth powder coated steel, varnished brass, polycarbonate tube

### Colors

Brass and translucent

### Origin

France

## TECHNICAL SPECIFICATIONS



LUMINOUS FLUX  
15883 lumens



Integrated LED

EUROPE

UK

US



### Power

220-240 V 50-60Hz

### Power

220-240 V 50-60 Hz

### Power

110-120 V 60 Hz

17

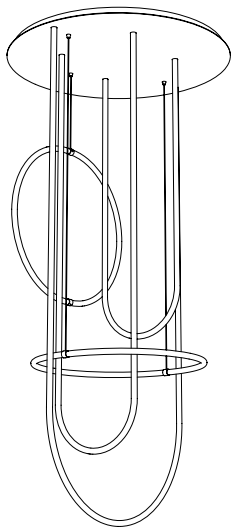

100.0 cm

**L:** 100.0 cm | 39.4 inches  
**H:** 210.0 cm | 82.7 inches  
**Weight:** 40.0 kg | 88.2 lb

### PACKAGING:

**L:** 150.0 cm | 59.1 inches  
**W:** 250.0 cm | 98.4 inches  
**H:** 83.0 cm | 32.7 inches  
**Weight:** 50.0 kg | 110.2 lb

**UNSEEN**

STUDIOPEPE

2020



Available while stock last

### Table lamps

#### Materials

Smooth powder coated steel, varnished brass, polycarbonate tube

#### Colors

Brass and translucent

#### Origin

France

### TECHNICAL SPECIFICATIONS

Small



LED input:  
670 lumens

large



LED input:  
1650 lumens



Integrated LED



Power

220-240 V 50-60Hz

Power

220-240 V 50-60 Hz

Power

110-120 V 60 Hz

18

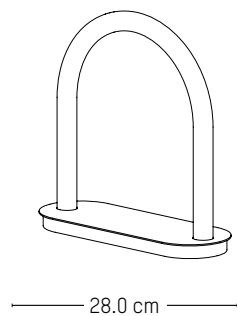

### Small table lamp

**L:** 28.0 cm | 11.0 inches  
**H:** 28.0 cm | 11.0 inches  
**D:** 10.0 cm | 3.9 inches  
**Weight:** 1.5 kg | 3.3 lb  
**Cable length:** 120.0 cm | 47.2 inches

PACKAGING:

**L:** 50.0 cm | 19.7 inches  
**W:** 50.0 cm | 19.7 inches  
**H:** 20.0 cm | 7.9 inches  
**Weight:** 3.0 kg | 6.6 lb

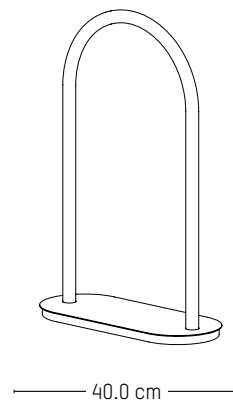

### Large table lamp

**L:** 40.0 cm | 15.7 inches  
**H:** 60.0 cm | 23.6 inches  
**D:** 17.0 cm | 6.5 inches  
**Weight:** 3.0 kg | 6.6 lb  
**Cable length:** 120.0 cm | 47.2 inches

PACKAGING:

**L:** 70.0 cm | 27.6 inches  
**W:** 20.0 cm | 7.9 inches  
**H:** 70.0 cm | 27.6 inches  
**Weight:** 5.0 kg | 11.0 lb



**UNSEEN**

STUDIOPEPE

2020



Pendant lamp U



Pendant lamp O

**Pendant lamps**

**Materials**

Smooth powder coated steel, varnished brass, polycarbonate tube

**Colours**

Brass and translucent

**Origin**

France

**TECHNICAL SPECIFICATIONS**

For recessed ceilings

Lamp J

**LED 12W** LUMINOUS FLUX 1030 lumens

lamp o

**LED 7.6W** LUMINOUS FLUX 660 lumens

lamp u

**LED 8.5W** LUMINOUS FLUX 720 lumens



Integrated LED



**Power**

220-240 V 50-60Hz

**Power**

220-240 V 50-60 Hz

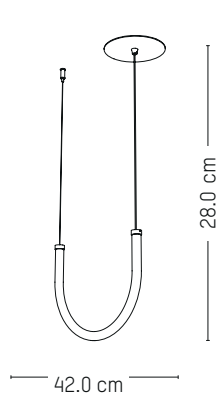

**Pendant lamp U**

**L:** 35.0 cm | 13.8 inches  
**D:** 3.0 cm | 1.2 inches  
**H:** 28.0 cm | 11.0 inches  
**Weight:** 1.0 kg | 2.1 lb  
**Cable length (max):** 2.5 m | 98.4 inches

PACKAGING:

**L:** 46.7 cm | 18.4 inches  
**W:** 42.6 cm | 16.8 inches  
**H:** 6.8 cm | 2.7 inches  
**Weight:** 2.0 kg | 4.4 lb

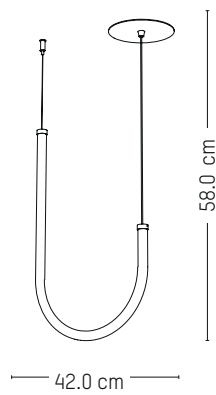

**Pendant lamp J**

**L:** 35.0 cm | 13.8 inches  
**D:** 3.0 cm | 1.2 inches  
**H:** 58.0 cm | 22.8 inches  
**Weight:** 1.5 kg | 3.3 lb  
**Cable length (max):** 2.5 m | 98.4 inches

PACKAGING:

**L:** 62.5 cm | 24.6 inches  
**W:** 46.7 cm | 18.4 inches  
**H:** 6.8 cm | 2.7 inches  
**Weight:** 2.5 kg | 5.5 lb

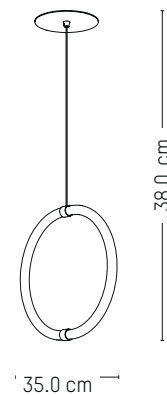

**Pendant lamp O**

**L:** 38.0 cm | 15.0 inches  
**D:** 3.0 cm | 1.2 inches  
**H:** 35.0 cm | 13.8 inches  
**Weight:** 1.3 kg | 3.1 lb  
**Cable length (max):** 2.5 m | 98.4 inches

PACKAGING:

**L:** 46.7 cm | 18.4 inches  
**W:** 42.6 cm | 16.8 inches  
**H:** 6.8 cm | 2.7 inches  
**Weight:** 2.5 kg | 5.5 lb



# UNSEEN

STUDIOPEPE

2020



## Pendant lamps canopy

-

Materials

Varnished brass

Colour

Brass

Origin

France

### TECHNICAL SPECIFICATIONS

To combine with unit pendant lamp for regular ceiling

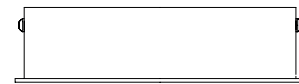
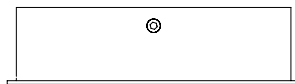
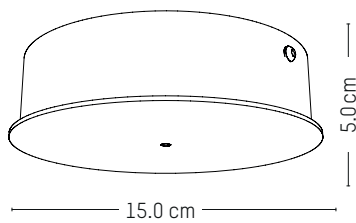

## Pendant lamp canopy

-

**Ø:** 15.0 cm | 5.9 inches

**H:** 5.0 cm | 2.0 inches

**Weight:** 0.9 kg | 2.0 lb

### PACKAGING:

**L:** 15.0 cm | 5.9 inches

**W:** 15.0 cm | 5.9 inches

**H:** 16.0 cm | 6.3 inches

**Weight:** 1.1 kg | 2.4 lb

**UNSEEN**

STUDIOPEPE

2020



Pendant lamp U



Pendant lamp O

**Pendant lamps**

**Materials**

Smooth powder coated steel, varnished brass, polycarbonate tube

**Colours**

Brass and translucent

**Origin**

France

**TECHNICAL SPECIFICATIONS**

For recessed ceilings

**Lamp J**

**LED 12W** LUMINOUS FLUX 1030 lumens

**lamp o**

**LED 7.6W** LUMINOUS FLUX 660 lumens

**lamp u**

**LED 8.5W** LUMINOUS FLUX 720 lumens



Integrated LED



**Power**

110-120 V 60 Hz

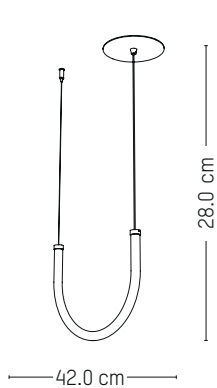

**Pendant lamp U**

**L:** 42.0 cm | 16.5 inches  
**D:** 2.4 cm | 1.0 inches  
**H:** 28.0 cm | 11.0 inches  
**Weight:** 1.0 kg | 2.1 lb  
**Cable length (max):** 2.5 m | 98.4 inches

**PACKAGING:**

**L:** 46.7 cm | 18.4 inches  
**W:** 42.6 cm | 16.8 inches  
**H:** 6.8 cm | 2.7 inches  
**Weight:** 2.0 kg | 4.4 lb

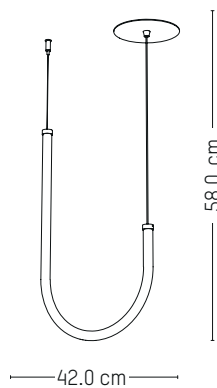

**Pendant lamp J**

**L:** 42.0 cm | 16.5 inches  
**D:** 2.4 cm | 1.0 inches  
**H:** 58.0 cm | 22.8 inches  
**Weight:** 1.5 kg | 3.3 lb  
**Cable length (max):** 2.5 m | 98.4 inches

**PACKAGING:**

**L:** 62.5 cm | 24.6 inches  
**W:** 46.7 cm | 18.4 inches  
**H:** 6.8 cm | 2.7 inches  
**Weight:** 2.5 kg | 5.5 lb

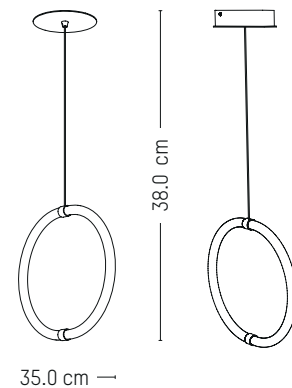

**Pendant lamp O**

**L:** 35.0 cm | 13.8 inches  
**D:** 2.4 cm | 1.0 inches  
**H:** 38.0 cm | 15.0 inches  
**Weight:** 1.4 kg | 3.1 lb  
**Cable length (max):** 2.5 m | 98.4 inches

**PACKAGING:**

**L:** 46.7 cm | 18.4 inches  
**W:** 42.6 cm | 16.8 inches  
**H:** 6.8 cm | 2.7 inches  
**Weight:** 2.5 kg | 5.5 lb

# VERTIGO NOVA

CONSTANCE GUISSET

2020



## Pendant lamps

### Materials

**Lampshade:** Fiberglass, steel with matte grained powder coating, polyurethane ribbons, **Glass:** Glass triplex  
**Lighting system:** painted aluminium  
**Cable:** mesh textile

### Colors

Black, White

### Origin

France

## TECHNICAL SPECIFICATIONS



LUMINOUS FLUX  
825 lumens



Integrated LED



White shade,  
White glass



Black shade,  
white glass



### Power

220-240 V 50-60Hz



### Power

220-240 V 50-60 Hz



### Power

110-120 V 60 Hz

22

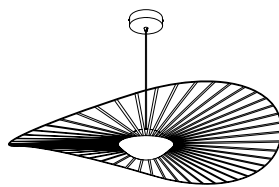

110.0 cm

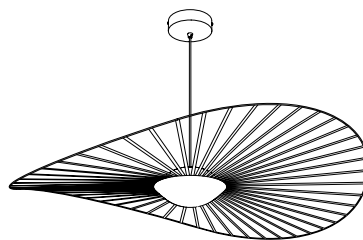

140.0 cm

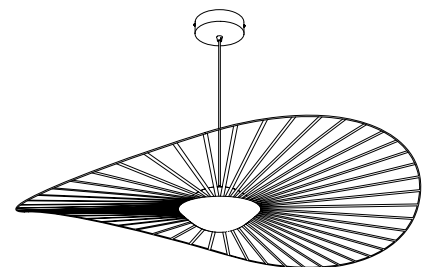

190.0 cm

## Small

**Ø:** 110.0 cm | 43.3 inches  
**H:** 11.5 cm | 4.5 inches  
**Weight:** 2.0 kg | 4.4 lb  
**Cable length:** 300.0 cm | 118.1 inches  
**or on demand:** 1000.0 cm | 393.7 inches

### PACKAGING:

**L:** 72.0 cm | 28.3 inches  
**W:** 72.0 cm | 28.3 inches  
**H:** 35.0 cm | 13.8 inches  
**Weight:** 5.5 kg | 13.8 lb

## Medium

**Ø:** 140.0 cm | 55.1 inches  
**H:** 12.0 cm | 4.7 inches  
**Weight:** 2.5 kg | 5.5 lb  
**Cable length:** 300.0 cm | 118.1 inches  
**or on demand:** 1000.0 cm | 393.7 inches

### PACKAGING:

**L:** 72.0 cm | 28.3 inches  
**W:** 72.0 cm | 28.3 inches  
**H:** 35.0 cm | 13.8 inches  
**Weight:** 5.5 kg | 12.1 lb

## Large

**Ø:** 190.0 cm | 74.8 inches  
**H:** 13.2 cm | 5.2 inches  
**Weight:** 3.1 kg | 6.8 lb  
**Cable length:** 300.0 cm | 118.1 inches  
**or on demand:** 1000.0 cm | 393.7 inches

### PACKAGING:

**L:** 72.0 cm | 28.3 inches  
**W:** 72.0 cm | 28.3 inches  
**H:** 35.0 cm | 13.8 inches  
**Weight:** 7.0 kg | 15.4 lb



# VERTIGO NOVA

CONSTANCE GUISSET

2020

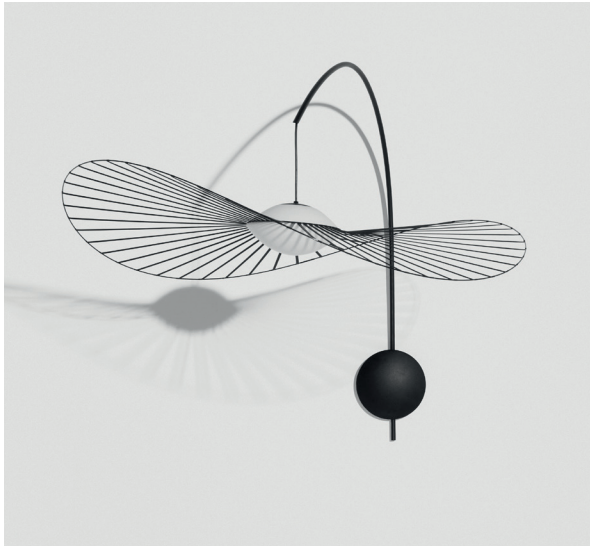

White shade,  
White glass



Black shade,  
white glass

## Wall lamp

-

### Materials

**Lampshade:** Fiberglass, painted steel with matte grained powder coating, polyurethane ribbons

**Glass:** Glass triplex

**Cable:** mesh textile. Included cable for regular plug

### Colors

Black, White

### Origin

France

## TECHNICAL SPECIFICATIONS



LUMINOUS FLUX  
825 lumens



Integrated LED

EUROPE

UK

US



Power

220-240 V 50-60Hz

Power

220-240 V 50-60 Hz

Power

110-120 V 60 Hz

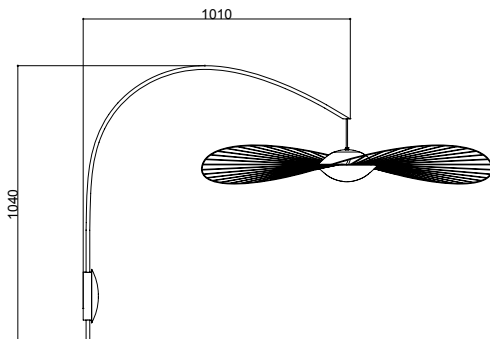

**Ø:** 110.0 cm | 43.3 inches  
**H:** 104.0 cm | 40.9 inches  
**Canopy:** Ø 15.0 cm | 7.1 inches  
**Weight:** 3.2 kg | 7.1 lb

### PACKAGING:

#### Carton box 1

**L:** 130.0 cm | 51.2 inches  
**W:** 61.0 cm | 24.0 inches  
**H:** 15.7 cm | 6.2 inches  
**Weight:** 5.0 kg | 11.0 lb

#### Carton box 2

**L:** 72.0 cm | 28.3 inches  
**W:** 72.0 cm | 28.3 inches  
**H:** 22.0 cm | 8.7 inches  
**Weight:** 2.0 kg | 4.4 lb

# VERTIGO NOVA

CONSTANCE GUISET

2020



White shade,  
White glass



Black shade,  
white glass

## Floor lamp

### Materials

**Lampshade:** Fiberglass, painted steel with matte grained powder coating, polyurethane ribbons

**Glass:** Glass triplex

**Cable:** mesh textile + With foot dimmer

### Colors

Black, White

### Origin

France

### TECHNICAL SPECIFICATIONS



LUMINOUS FLUX  
825 lumens



Integrated LED



### Power

220-240 V 50-60Hz

### Power

220-240 V 50-60 Hz

### Power

110-120 V 60 Hz

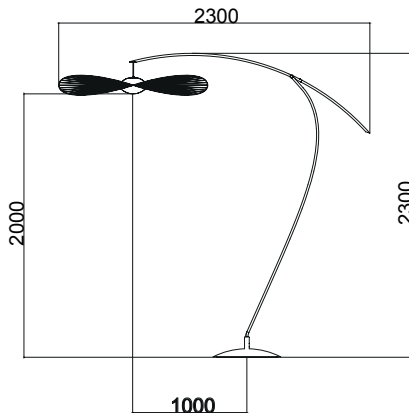

High position

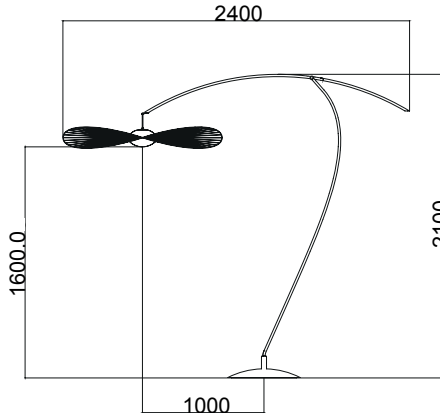

Low position

### PACKAGING:

#### Carton box 1

**L:** 234.0 cm | 92.1 inches

**W:** 51.7 cm | 20.4 inches

**H:** 15.7 cm | 6.2 inches

**Weight:** 25.0 kg | 55.1 lb

#### Carton box 2

**L:** 72.0 cm | 28.3 inches

**W:** 72.0 cm | 28.3 inches

**H:** 22.0 cm | 8.7 inches

**Weight:** 2.0 kg | 4.4 lb

**L (max):** 230.0 cm | 90.6 inches or 210.0 cm | 82.7 inches

**W:** 110.0 cm | 43.3 inches

**Ø:** 110.0 cm | 43.3 inches

**H (max):** 230.0cm | 90.6 inches or 240.0 cm | 94.5 inches

**Weight:** 20.0 kg | 44.1 lb



# MEDITERRANEA

NOÉ DUCHAUFOUR-LAWRANCE

2016



CE VERSION



Brushed brass

## Pendant lamp

Materials

Brushed brass

Color

Brushed brass

Origin

France

### TECHNICAL SPECIFICATIONS

Small

LED 14W

LUMINOUS FLUX 926 lumens

large

LED 24W

LUMINOUS FLUX 1620 lumens



Integrated LED

EUROPE

UK

CE

UK CA

Power

220-240 V 50-60Hz

Power

220-240 V 50-60 Hz

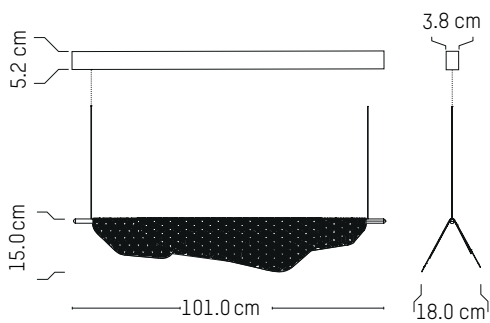

### Small

L: 101.0 cm | 39.6 inches

W: 18.0 cm | 7.1 inches

H: 15.0 cm | 5.9 inches

Cable length: 250.0 cm | 98.4 inches

Weight: 4.0 kg | 8.8 lb

PACKAGING:

L: 109.0 cm | 42.9 inches

W: 25.0 cm | 9.8 inches

H: 30.0 cm | 11.8 inches

Weight: 4.7 kg | 10.4 lb

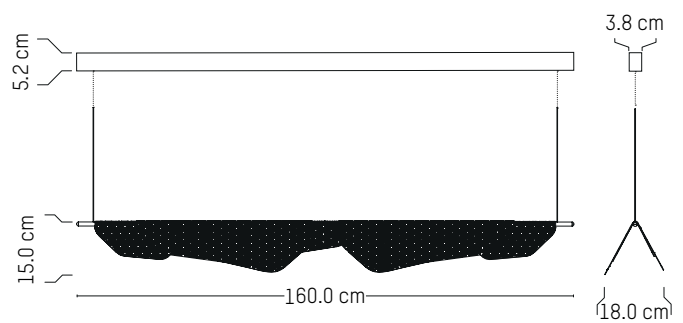

### Large

L: 160.0 cm | 63.0 inches

W: 25.0 cm | 9.8 inches

H: 15.0 cm | 5.9 inches

Cable length: 250.0 cm | 98.4 inches

Weight: 6.0 kg | 13.2 lb

PACKAGING:

L: 167.0 cm | 65.7 inches

W: 25.0 cm | 9.8 inches

H: 30.0 cm | 11.8 inches

Weight: 7.0 kg | 15.4 lb

# MEDITERRANEA

NOÉ DUCHAUFOUR-LAWRANCE

2016



Brushed brass

## Pendant lamp

Materials

Brushed brass

Color

Brushed brass

Origin

France

### TECHNICAL SPECIFICATIONS

Small

LED 14W

LUMINOUS FLUX 926 lumens

large

LED 24W

LUMINOUS FLUX 1620 lumens



Integrated LED



Power

110-120 V 60 Hz

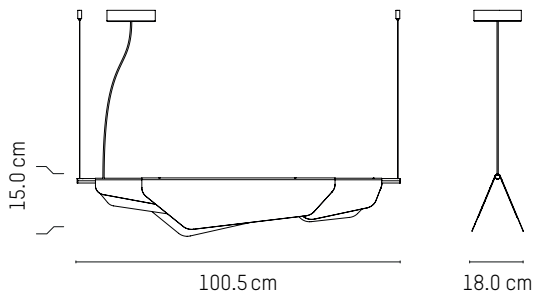

### Small

L: 101.0 cm | 39.6 inches

W: 18.0 cm | 7.1 inches

H: 15.0 cm | 5.9 inches

Cable length: 250.0 cm | 98.4 inches

Weight: 4.0 kg | 8.8 lb

PACKAGING:

L: 109.0 cm | 42.9 inches

W: 25.0 cm | 9.8 inches

H: 30.0 cm | 11.8 inches

Weight: 4.7 kg | 10.4 lb

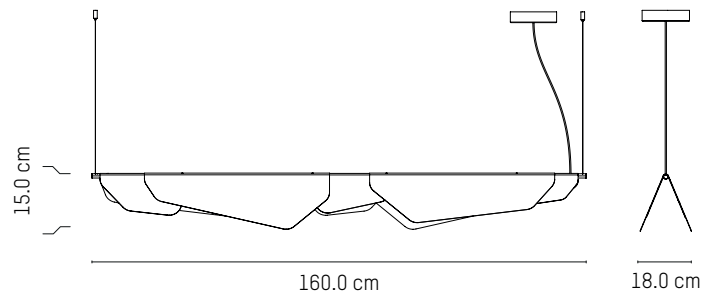

### Large

L: 160.0 cm | 63.0 inches

W: 25.0 cm | 9.8 inches

H: 15.0 cm | 5.9 inches

Cable length: 250.0 cm | 98.4 inches

Weight: 6.0 kg | 13.2 lb

PACKAGING:

L: 167.0 cm | 65.7 inches

W: 25.0 cm | 9.8 inches

H: 30.0 cm | 11.8 inches

Weight: 7.0 kg | 15.4 lb

# MEDITERRANEA

NOÉ DUCHAUFOUR-LAWRANCE

2016

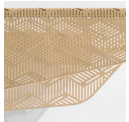
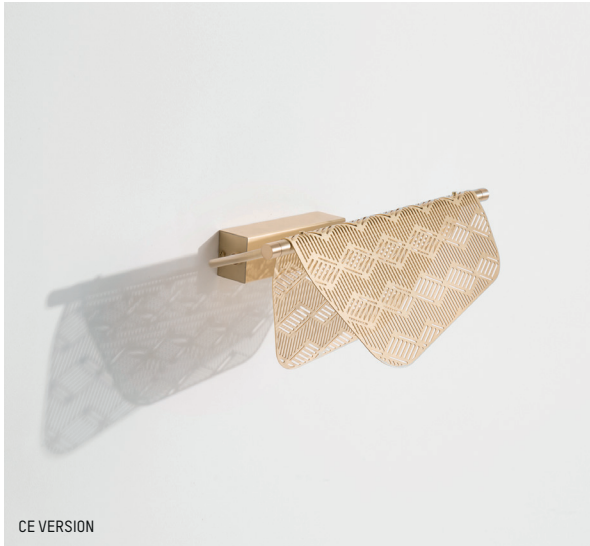

Brushed  
brass

## Wall lamp

-

Materials

Brushed brass

Color

Brushed brass

Origin

France

### TECHNICAL SPECIFICATIONS



LUMINOUS FLUX  
234 lumens



Integrated LED

EUROPE

UK



Power

220-240 V 50-60Hz

Power

220-240 V 50-60 Hz

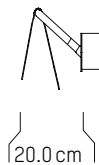
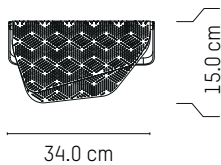

**L:** 34.0 cm | 13.4 inches  
**D:** 20.0 cm | 7.9 inches  
**H:** 15.0 cm | 5.9 inches  
**Weight:** 1.0 kg | 2.2 lb

PACKAGING:

**Type:** Carton box  
**L:** 42.0 cm | 16.5 inches  
**W:** 32.0 cm | 12.6 inches  
**H:** 24.0 cm | 9.4 inches  
**Weight:** 2.1 kg | 4.6 lb

# MEDITERRANEA

NOÉ DUCHAUFOUR-LAWRANCE

2016



UL VERSION



Brushed brass

## Wall lamp

-

### Materials

Brushed or painted brass

### Colors

Brushed brass, White, Black

### Origin

France

### TECHNICAL SPECIFICATIONS



LUMINOUS FLUX  
234 lumens



Integrated LED



US



### Power

110-120 V 60 Hz

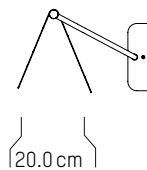
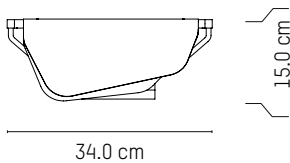

**L:** 34.0 cm | 13.4 inches

**D:** 20.0 cm | 7.9 inches

**H:** 15.0 cm | 5.9 inches

**Weight:** 1.0 kg | 2.2 lb

### PACKAGING:

**Type:** Carton box

**L:** 42.0 cm | 16.5 inches

**W:** 32.0 cm | 12.6 inches

**H:** 24.0 cm | 9.4 inches

**Weight:** 2.1 kg | 4.6 lb

# MEDITERRANEA

NOÉ DUCHAUFOUR-LAWRANCE

2016



Brushed brass

## Table and Floor lamp

### Materials

Brushed or painted brass  
Cable: plastic

### Colors

Brushed brass, White, Black

### Origin

France

### TECHNICAL SPECIFICATIONS

LUMINOUS FLUX  
FLOOR LAMP - 312 lumens  
TABLE LAMP - 216 lumens

LED  
5W  
4W



Integrated LED

EUROPE

UK



### Power

220-240 V 50-60Hz

### Power

220-240 V 50-60 Hz

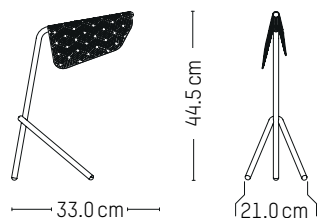

## Table lamp

**L:** 33.0 cm | 13.0 inches  
**W:** 21.0 cm | 8.3 inches  
**H:** 44.5 cm | 17.5 inches  
**Cable length:** 170.0 cm | 66.9 inches  
**Weight:** 1.3 kg | 2.9 lb

### PACKAGING:

**Type:** Carton box  
**L:** 46.0 cm | 18.1 inches  
**W:** 45.0 cm | 17.7 inches  
**H:** 23.0 cm | 9.1 inches  
**Weight:** 2.7 kg | 6 lb

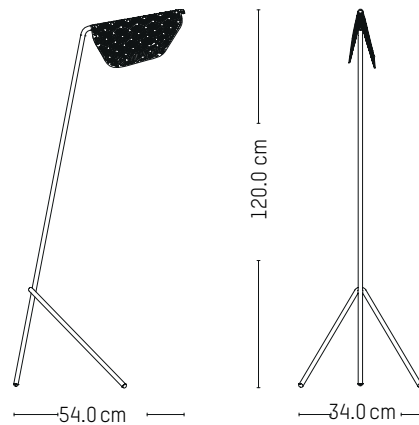

## Floor lamp

**L:** 54.0 cm | 21.3 inches  
**W:** 34.0 cm | 13.4 inches  
**H:** 120.0 cm | 47.2 inches  
**Cable length:** 170.0 cm | 66.9 inches  
**Weight:** 2.0 kg | 4.4 lb

### PACKAGING:

**Type:** Carton box  
**L:** 133.0 cm | 52.4 inches  
**W:** 54.0 cm | 21.3 inches  
**H:** 25.0 cm | 9.8 inches  
**Weight:** 6.6 kg | 14.6 lb

# MEDITERRANEA

NOÉ DUCHAUFOUR-LAWRANCE

2016



Brushed brass

## Table and Floor lamp

### Materials

Brushed or painted brass

**Cable:** plastic

### Colors

Brushed brass, White, Black

### Origin

France

### TECHNICAL SPECIFICATIONS

LUMINOUS FLUX  
FLOOR LAMP - 312 lumens  
TABLE LAMP - 216 lumens

LED  
5W  
4W



Integrated LED



### Power

110-120 V 60 Hz

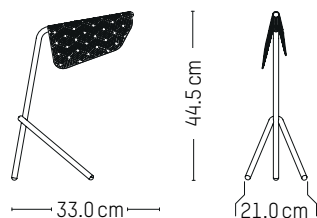

## Table lamp

**L:** 33.0 cm | 13.0 inches

**W:** 21.0 cm | 8.3 inches

**H:** 44.5 cm | 17.5 inches

**Cable length:** 170.0 cm | 66.9 inches

**Weight:** 1.3 kg | 2.9 lb

### PACKAGING:

**Type:** Carton box

**L:** 46.0 cm | 18.1 inches

**W:** 45.0 cm | 17.7 inches

**H:** 23.0 cm | 9.1 inches

**Weight:** 2.7 kg | 6 lb

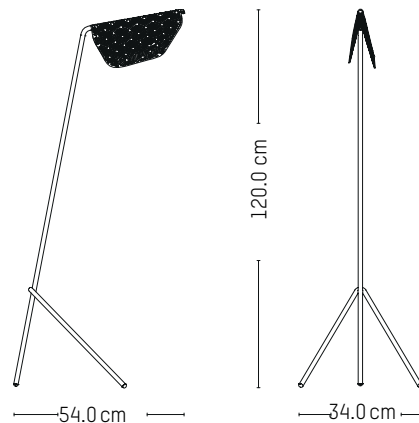

## Floor lamp

**L:** 54.0 cm | 21.3 inches

**W:** 34.0 cm | 13.4 inches

**H:** 120.0 cm | 47.2 inches

**Cable length:** 170.0 cm | 66.9 inches

**Weight:** 2.0 kg | 4.4 lb

### PACKAGING:

**Type:** Carton box

**L:** 133.0 cm | 52.4 inches

**W:** 54.0 cm | 21.3 inches

**H:** 25.0 cm | 9.8 inches

**Weight:** 6.6 kg | 14.6 lb

# TIDELIGHT

PIERRE FAVRESSE

2012

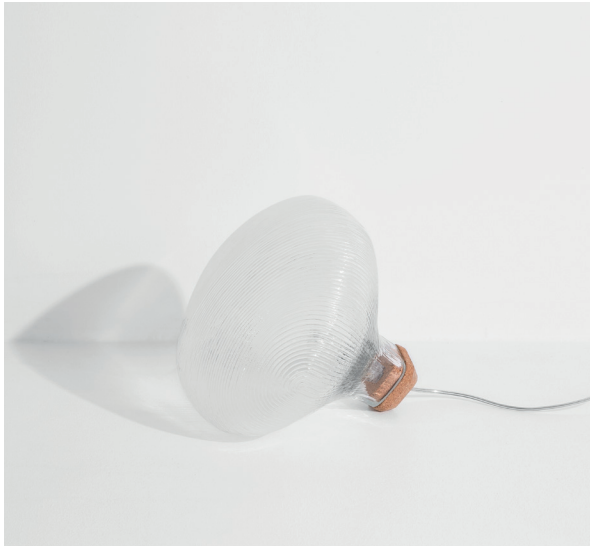

## Table Lamp

-

### Materials

Lampshade: Blown glass; Base: cork

### Colors

Clear-transparent

### Origin

Poland

### TECHNICAL SPECIFICATIONS



### Power

220-240 V 50-60Hz

### Power

220-240 V 50-60 Hz

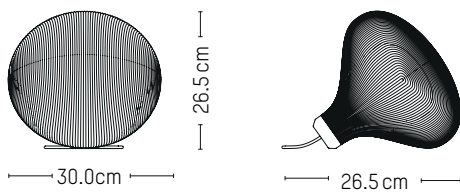

**Ø:** 30.0 cm | 11.8 inches

**W:** 26.5 cm | 10.4 inches

**H:** 26.5 cm | 10.4 inches

**Cable length:** 180.0 cm | 70.9 inches

**Weight:** 2.0 kg | 4.4 lb

### PACKAGING:

**L:** 37.0 cm | 14.6 inches

**W:** 37.0 cm | 14.6 inches

**H:** 37.5 cm | 14.8 inches

**Weight:** 2.7 kg | 6 lb

# VERTIGO

## CONSTANCE GUISET

Ø 110 CM: 2022 - Ø140 & Ø 200 CM: 2010



Black



Copper



White



Cobalt



Beetle

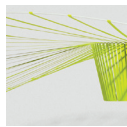

Neon Yellow  
Limited Edition  
Available while  
stock last



Bronze  
Ø140 & Ø200cm only  
Available while stock last

### Pendant lamps

Materials

**Pendant:** Fiberglass, lacquered steel, polyurethane ribbons

**Cable:** mesh textile

**Ceiling rose and socket:** powder coated steel

Colors

Black, White, Copper, Cobalt, Beetle, Neon Yellow limited edition, Bronze

Origin

France

### TECHNICAL SPECIFICATIONS



EUROPE

UK

US



Power

220-240 V 50-60Hz

Power

220-240 V 50-60 Hz

Power

110-120 V 60 Hz

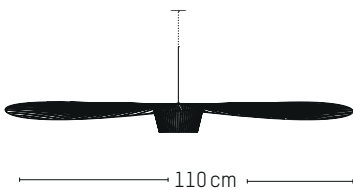

### Ø110 CM

Ø: 110.0 cm | 43.3 inches  
Weight: 0.5 kg | 1.1 lb  
Cable length: 300.0 cm | 118.1 inches or  
on demand: 1000.0 cm | 393.7 inches

PACKAGING:

Type: Carton box  
L: 72.5 cm | 28.5 inches  
W: 72.5 cm | 28.5 inches  
H: 21.0 cm | 8.3 inches  
Weight: 2.5 kg | 5.5 lb

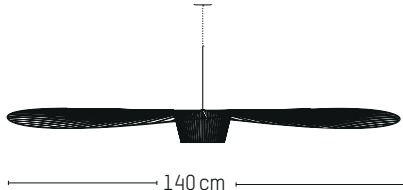

### Ø140CM

Ø: 140.0 cm | 55.1 inches  
Weight: 0.5 kg | 1.1 lb  
Cable length: 300.0 cm | 118.1 inches or  
on demand: 1000.0 cm | 393.7 inches

PACKAGING:

Type: Carton box  
L: 72.5 cm | 28.5 inches  
W: 72.5 cm | 28.5 inches  
H: 21.0 cm | 8.3 inches  
Weight: 2.5 kg | 5.5 lb

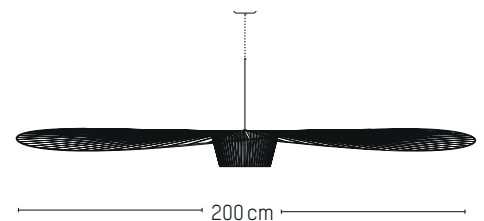

### Ø200 CM

Ø: 200 cm | 78.7 inches  
Weight: 0.7 kg | 1.5 lb  
Cable length: 300.0 cm | 118.1 inches or  
on demand: 1000.0 cm | 393.7 inches

PACKAGING:

Type: Carton box  
L: 72.5 cm | 28.5 inches  
W: 72.5 cm | 28.5 inches  
H: 21.0 cm | 8.3 inches  
Weight: 2.5 kg | 5.5 lb



**FURNITURE**



# WANDER

AC/AL STUDIO

2022

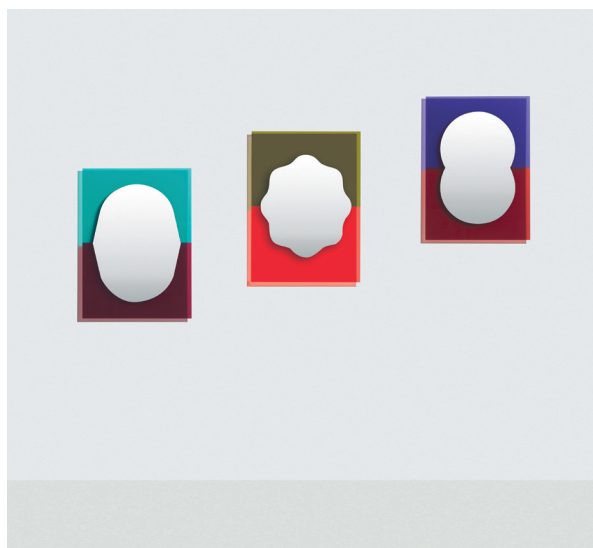

## Mirror S

-

### Materials

Mirrored glass, colored glass.

### Colors

Emerald and Cherry, Vermilion and Khaki, Purple and Brown Red

### Origin

France

### TECHNICAL SPECIFICATIONS

- Invisible wall fixation system included. Allows a position of the mirror 2cm away from the wall.
- Positioned only vertically.



Emerald  
Cherry



Vermilion  
Khaki



Purple  
Brown Red

35

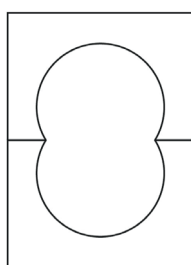
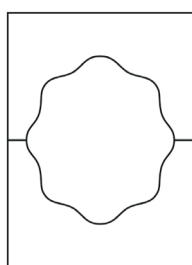
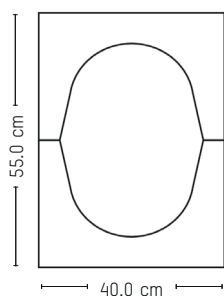

## Mirror S

-

**H:** 55.0 cm | 21.7 inches

**L:** 40.0 cm | 15.7 inches

**Weight:** 3.0 kg | 6.6 lb

### PACKAGING RETAIL

**L:** 59.0 cm | 23.2 inches

**W:** 44.0 cm | 17.3 inches

**H:** 4.0 cm | 1.6 inches

**Weight:** 5.0 kg | 11.0 lb

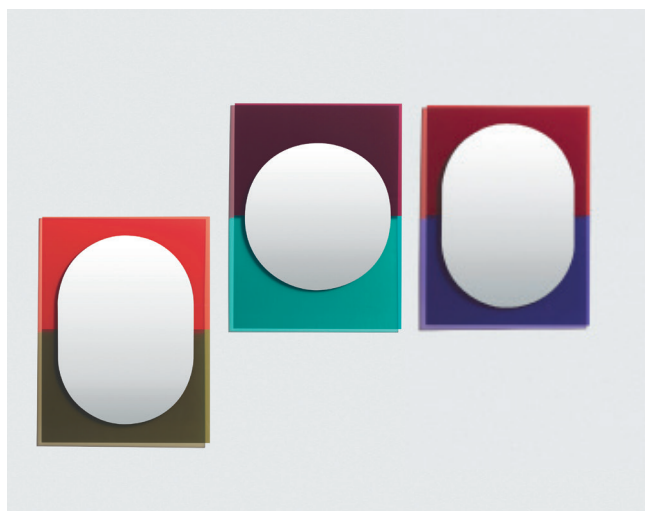

**Mirror M**

-

**Materials**

Mirrored glass, colored glass.

**Colors**

Emerald and Cherry, Vermillon and Khaki, Purple and Brown Red

**Origin**

France

**TECHNICAL SPECIFICATIONS**

- Invisible wall fixation system included. Allows a position of the mirror 2cm away from the wall.
- Positioned only vertically



Emerald  
Cherry



Vermillon  
Khaki



Purple  
Brown Red

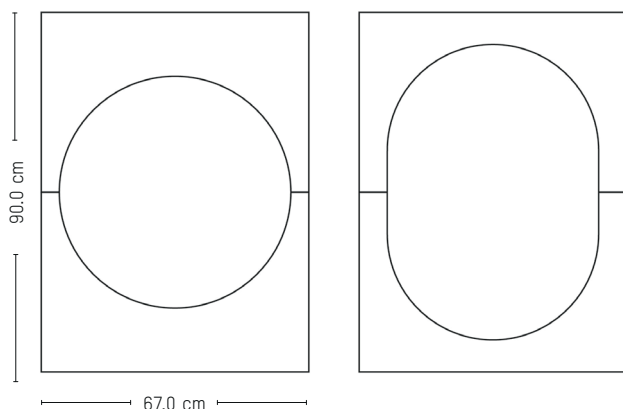

**Mirror M**

-

**H:** 90.0 cm | 35.4 inches

**L:** 67.0 cm | 26.4 inches

**Weight:** 9.0 kg | 19.8 lb

**PACKAGING RETAIL**

**L:** 94.0 cm | 37.0 inches

**W:** 71.0 cm | 28.0 inches

**H:** 4.0 cm | 1.6 inches

**Weight:** 11.0 kg | 24.3 lb

# WANDER

AC/AL STUDIO

2022

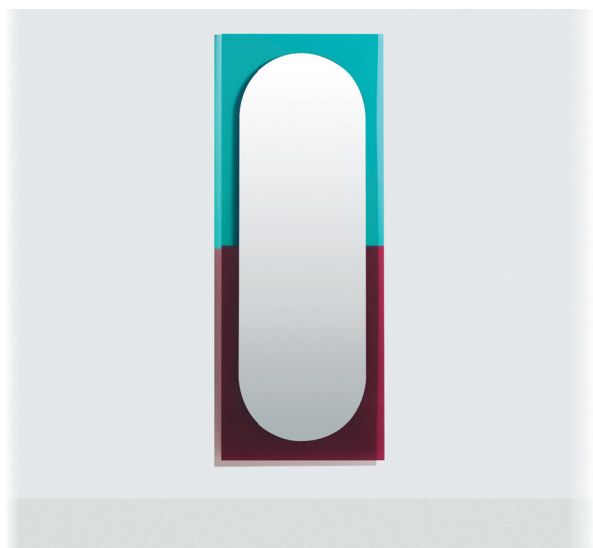

Emerald  
Cherry

## Mirror L

-

### Materials

Mirrored glass, colored glass.

### Colors

Emerald and Cherry.

### Origin

France

### TECHNICAL SPECIFICATIONS

- Invisible wall fixation system included. Allows a position of the mirror 2cm away from the wall.
- Can be positioned vertically and horizontally.

37

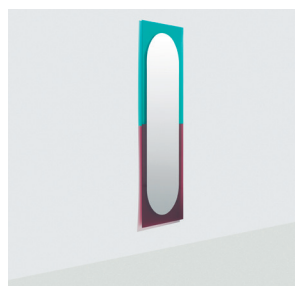
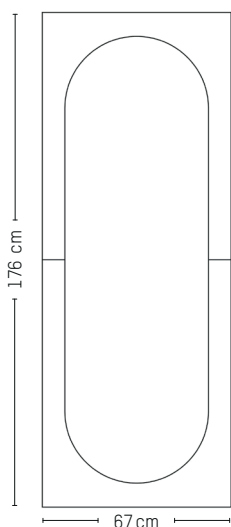

## Mirror L

-

**H:** 176.0 cm | 69.3 inches

**L:** 67.0 cm | 26.4 inches

**Weight:** 18.0 kg | 39.7 lb

### PACKAGING RETAIL

**L:** 180.0 cm | 70.9 inches

**W:** 71.0 cm | 28.0 inches

**H:** 4.0 cm | 1.6 inches

**Weight:** 20.0 kg | 44.1 lb

# FRANCIS

CONSTANCE GUISET

2011



## Mirrors

-

### Materials

Mirror

**Back:** Aluminium, with matte grained powder coating

**Fixing cord:** Fabric

### Colors

Black and blue-purple watercolor, Black and pink watercolor, Black and blue watercolor, White and green watercolor

### Origin

France



Black &  
Blue-purple  
watercolor



Black &  
Pink  
watercolor



Black &  
Blue  
watercolor



White &  
Green  
watercolor

S, M

XL

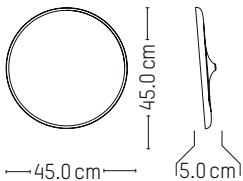

### Small

-

**Ø:** 45.0 cm | 17.7 inches

**D:** 5.0 cm | 2.0 inches

**Weight:** 3.5 kg | 7.7 lb

PACKAGING:

**Type:** Carton box

**L:** 52.0 cm | 20.5 inches

**W:** 52.0 cm | 20.5 inches

**H:** 11.0 cm | 4.3 inches

**Weight:** 4.7 kg | 10.4 lb

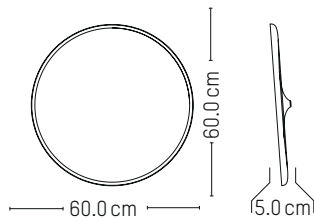

### Large

-

**Ø:** 60.0 cm | 23.6 inches

**D:** 5.0 cm | 2.0 inches

**Weight:** 7.0 kg | 15.4 lb

PACKAGING:

**Type:** Carton box

**L:** 68.0 cm | 26.8 inches

**W:** 68.0 cm | 26.8 inches

**H:** 11.0 cm | 4.3 inches

**Weight:** 8.5 kg | 18.7 lb

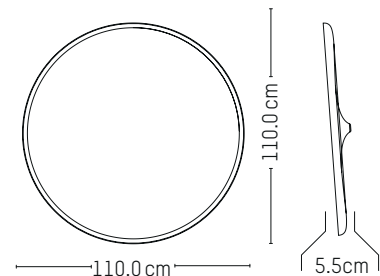

### Extra large

-

**Ø:** 110.0 cm | 43.3 inches

**D:** 5.5 cm | 2.2 inches

**Weight:** 23.0 kg | 50.7 lb

PACKAGING:

**Type:** Carton box

**L:** 118.0 cm | 46.5 inches

**W:** 118.0 cm | 46.5 inches

**H:** 9.5 cm | 3.7 inches

**Weight:** 28 kg | 61.7 lb

# FRANCIS

CONSTANCE GUISSET

2018



## Coffee tables

-

### Materials

Mirror

**Mirror shell and table leg:** Steel with matte grained powder coating

### Colors

Black and blue watercolor, White and green watercolor

### Origin

France



Black & Blue watercolor

White & Green watercolor

39

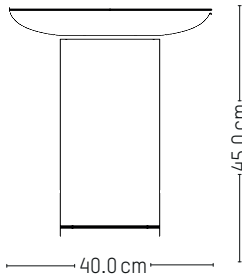

### Small

-

**D:** 40.0 cm | 15.7 inches

**H:** 45.0 cm | 17.7 lb

**Weight:** 8.0 kg | 17.6 lb

PACKAGING:

**Type:** Carton box

**L:** 52.0 cm | 20.5 inches

**W:** 52.0 cm | 20.5 inches

**H:** 50.0 cm | 19.7 inches

**Weight:** 11.0 kg | 24.3 lb

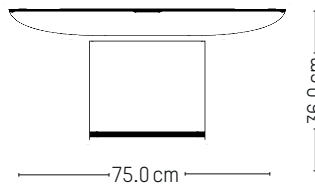

### Large

-

**D:** 75.0 cm | 29.5 inches

**H:** 36.0 cm | 14.2 inches

**Weight:** 19.0 kg | 41.9 lb

PACKAGING:

**Type:** Carton box

**L:** 86.0 cm | 33.9 inches

**W:** 86.0 cm | 33.9 inches

**H:** 39.0 cm | 15.4 inches

**Weight:** 24.0 kg | 52.9 lb

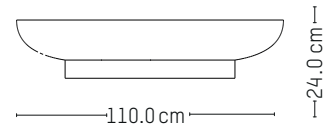

### Extra large

-

**D:** 110.0 cm | 43.3 inches

**H:** 24.0 cm | 9.4 inches

**Weight:** 45.0 kg | 99.2 lb

PACKAGING:

**Type:** Carton box

**L:** 118.0 cm | 46.5 inches

**W:** 118.0 cm | 46.5 inches

**H:** 28.0 cm | 11.0 inches





















**Weight:** 53.0 kg | 116.8 lb

# FROMME

TOM CHUNG

2019



 3012 BLUSH	 1016 YELLOW	 6019 PASTEL GREEN	 5002 BLUE	 7035 PEARL GREY
 8004 TERRACOTTA	 8000 GOLD	 6013 JADE GREEN	 5020 OCEAN BLUE	 DUNE
 2012 CORAL	 1015 IVORY	 6029 MINT GREEN	 5014 PIGEON BLUE	 9016 WHITE
 8012 BROWN RED	 1017 SAFFRON	 6007 GLASS GREEN	 5008 GREY BLUE	 9005 BLACK

## Chair

-

### Materials

Aluminium, matte grained Anti UV powder coating for outdoor use

### Colors

20 colors. RAL colors available with MOQ from our fine texture range (matt grained)

### Origin

China

### TECHNICAL SPECIFICATIONS

Compliant with EN 581-1 ; EN581-2 for Contract use and stackable up to 6 pieces.

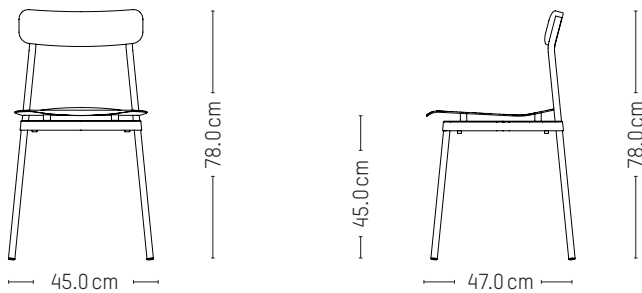

## Chair

-

**L:** 45.0 cm | 17.7 inches

**D:** 47.0 cm | 18.5 inches

**H:** 78.0 cm | 30.7 inches

**H (seat):** 45.0 cm | 17.7 inches

**Weight:** 3.8 kg | 8.4 lb

PACKAGING (x2):

**L:** 52.0 cm | 20.5 inches

**W:** 48.0 cm | 18.9 inches

**H:** 88.0 cm | 34.6 inches

**Weight:** 10.0 kg | 22.0 lb























# FROMME

TOM CHUNG

2021



 3012 BLUSH	 1016 YELLOW	 6019 PASTEL GREEN	 5002 BLUE	 7035 PEARL GREY
 8004 TERRACOTTA	 8000 GOLD	 6013 JADE GREEN	 5020 OCEAN BLUE	 DUNE
 2012 CORAL	 1015 IVORY	 6029 MINT GREEN	 5014 PIGEON BLUE	 9016 WHITE
 8012 BROWN RED	 1017 SAFFRON	 6007 GLASS GREEN	 5008 GREY BLUE	 9005 BLACK

## Lounge armchair

### Materials

Aluminium, matte grained Anti UV powder coating for outdoor use

### Colors

20 colors . RAL colors available with MOQ from our fine texture range (matt grained)

### Origin

China

### TECHNICAL SPECIFICATIONS

Compliant with EN 581-1 ; EN581-2 for Contract use and stackable by 4 pieces.

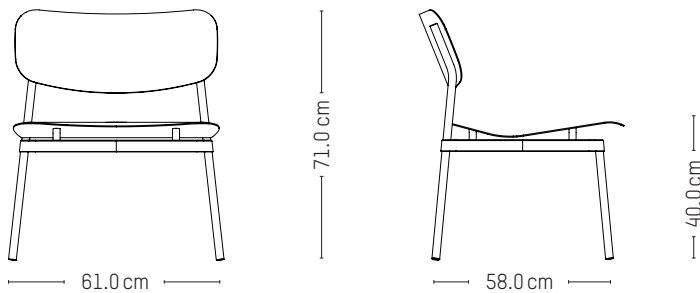

## Lounge armchair

**L:** 61.0 cm | 24.0 inches  
**D:** 58.0 cm | 22.8 inches  
**H:** 71.0 cm | 28.0 inches  
**H (seat):** 40.0 cm | 15.7 inches  
**Weight:** 5.9 kg | 13 lb

### PACKAGING:











**L:** 64.0 cm | 25.2 inches  
**W:** 59.0 cm | 23.2 inches  
**H:** 71.0 cm | 28.0 inches  
**Weight:** 8.0 kg | 17.6 lb

# FROMME

TOM CHUNG

2021



 3012 BLUSH	 1016 YELLOW	 6019 PASTEL GREEN	 5002 BLUE	 7035 PEARL GREY
 8004 TERRACOTTA	 8000 GOLD	 6013 JADE GREEN	 5020 OCEAN BLUE	 DUNE
 2012 CORAL	 1015 IVORY	 6029 MINT GREEN	 5014 PIGEON BLUE	 9016 WHITE
 8012 BROWN RED	 1017 SAFFRON	 6007 GLASS GREEN	 5008 GREY BLUE	 9005 BLACK

## Stool

-

### Materials

Aluminium, matte grained Anti UV powder coating for outdoor use

### Colors

20 colors. RAL colors available with MOQ from our fine texture range (matt grained)

### Origin

China

### TECHNICAL SPECIFICATIONS

Compliant with EN 581-1 ; EN581-2 for Contract use and stackable up to 6.

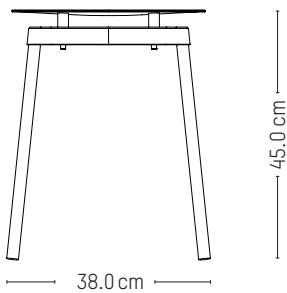

## Stool

-

**L:** 38.0 cm | 15.0 inches

**D:** 38.0 cm | 15.0 inches

**H:** 45.0 cm | 17.7 inches

**Weight:** 2.6 kg | 5.7 lb

PACKAGING (x2):

**L:** 40.0 cm | 15.7 inches

**W:** 40.0 cm | 15.7 inches

**H:** 55.0 cm | 21.7 inches





















**Weight:** 7.0 kg | 15.4 lb

# FROMME

TOM CHUNG

2021



 3012 BLUSH	 1016 YELLOW	 6019 PASTEL GREEN	 5002 BLUE	 7035 PEARL GREY
 8004 TERRACOTTA	 8000 GOLD	 6013 JADE GREEN	 5020 OCEAN BLUE	 DUNE
 2012 CORAL	 1015 IVORY	 6029 MINT GREEN	 5014 PIGEON BLUE	 9016 WHITE
 8012 BROWN RED	 1017 SAFFRON	 6007 GLASS GREEN	 5008 GREY BLUE	 9005 BLACK

## High Stool

### Materials

Aluminium, matte grained Anti UV powder coating for outdoor use

### Colors

20 color. RAL colors available with MOQ from our fine texture range (matt grained)

### Origin

China

### TECHNICAL SPECIFICATIONS

Compliant with EN 581-1 ; EN581-2 for Contract use and stackable up to 4 pieces.

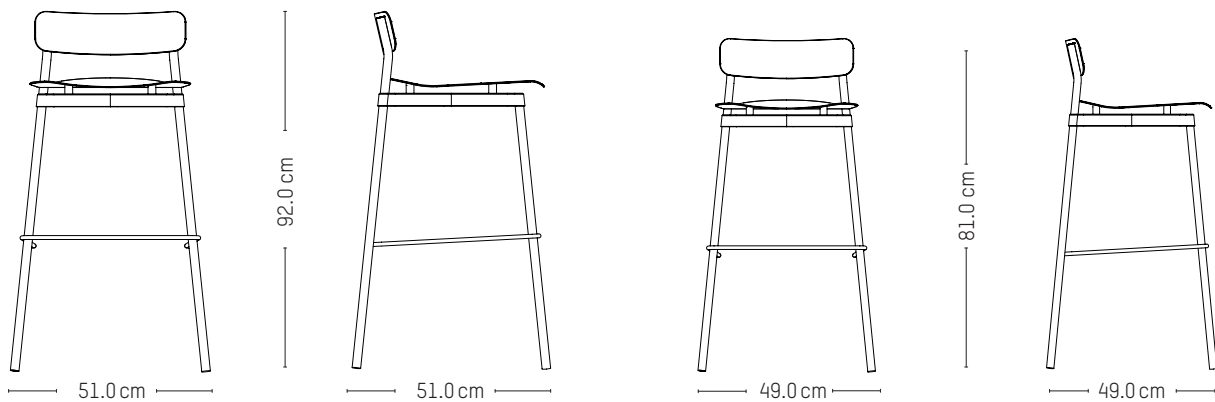

## High stool H75

**L:** 51.0 cm | 20.1 inches  
**D:** 51.0 cm | 20.1 inches  
**H:** 92.0 cm | 36.2 inches  
**H (seat):** 75.0 cm | 29.5 inches  
**Weight:** 4.5 kg | 9.9 lb

### PACKAGING:

**L:** 53.0 cm | 20.9 inches  
**W:** 53.0 cm | 20.9 inches  
**H:** 93 cm | 36.6 inches  
**Weight:** 6.5 kg | 14.3 lb

## High stool H65

**L:** 49.0 cm | 19.3 inches  
**D:** 49.0 cm | 19.3 inches  
**H:** 81.0 cm | 31.9 inches  
**H (seat):** 65.0 cm | 25.6 inches  
**Weight:** 4.1 kg | 9.0 lb

### PACKAGING:

**L:** 53.0 cm | 20.9 inches  
**W:** 53.0 cm | 20.9 inches  
**H:** 83.0 cm | 32.7 inches  
**Weight:** 6.1 kg | 13.4 lb

## FROMME WOOD

TOM CHUNG

2023



Black



Brown-red

### WOOD



Black



Brown-red

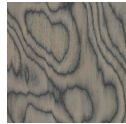

Sottsass Grey 18.73  
by Alpi

### UPHOLSTERY



Shake  
by Rohi

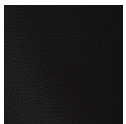

Leather

### Chair

-

**L:** 45.0 cm | 17.7 inches  
**D:** 47.0 cm | 18.5 inches  
**H:** 78.0 cm | 30.7 inches  
**H (seat):** 45.0 cm | 17.7 inches  
**Weight:** 3.3 kg | 7.3 lb

### PACKAGING:

**L:** 49.0 cm | 19.3 inches  
**W:** 49.0 cm | 19.3 inches  
**H:** 81.0 cm | 31.9 inches  
**Weight:** 5.2 kg | 11.5 lb

### Chair

-

#### Materials

Aluminium, matte grained powder coating tinted beech wood or natural Alpi veneered beech wood.

#### Colors

Black, Brown-red

#### Origin

Europe

### TECHNICAL SPECIFICATIONS

Compliant with EN16139 for Contract use and stackable up to 6 pieces.

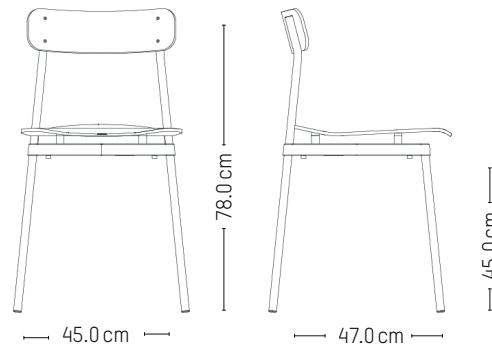

# FROMME WOOD

TOM CHUNG

2023



## STRUCTURE



Black



Brown-red

## WOOD

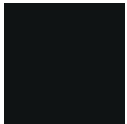

Black



Brown-red



Sottsass Grey 18.73  
by Alpi

## UPHOLSTERY



Shake  
by Rohi



Leather

## Lounge armchair

**L:** 61.0 cm | 24.0 inches  
**D:** 58.0 cm | 22.8 inches  
**H:** 71.0 cm | 28.0 inches  
**H (seat):** 40.0 cm | 15.7 inches  
**Weight:** 5.3 kg | 11.7 lb

## PACKAGING:

**L:** 64.0 cm | 25.2 inches  
**W:** 59.0 cm | 23.2 inches  
**H:** 75.0 cm | 29.5 inches  
**Weight:** 7.6 kg | 16.8 lb

## Lounge armchair

### Materials

Aluminium, matte grained powder coating tinted beech wood or natural Alpi veneered beech wood.

### Colors

Black, Brown-red

### Origin

Europe

## TECHNICAL SPECIFICATIONS

Compliant with EN16139 for Contract use and stackable up to 4 pieces.

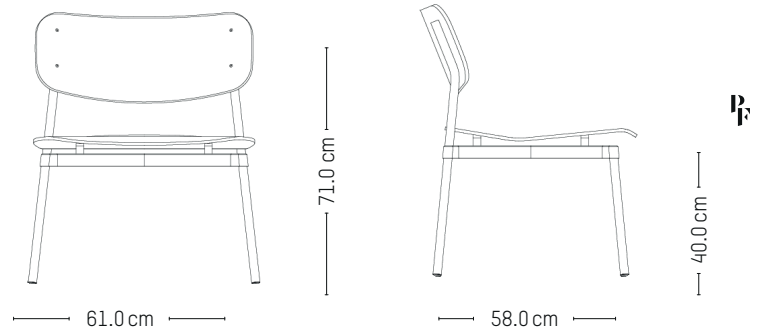

## FROMME WOOD

TOM CHUNG

2023



### STRUCTURE



Black



Brown-red

### WOOD

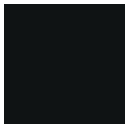

Black



Brown-red



Sottsass Grey 18.73  
by Alpi

### UPHOLSTERY

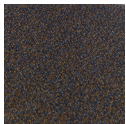

Shake  
by Rohi

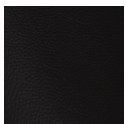

Leather

### High stool

-

**L:** 51.0 cm | 20.1 inches  
**D:** 51.0 cm | 20.1 inches  
**H:** 91.0 cm | 35.8 inches  
**H (seat):** 75.0 cm | 29.5 inches  
**Weight:** 4.0 kg | 8.8 lb

### PACKAGING:

**L:** 53.0 cm | 20.9 inches  
**W:** 53.0 cm | 20.9 inches  
**H:** 95 cm | 37.4 inches  
**Weight:** 6.0 kg | 13.2 lb

### High Stool

-

#### Materials

Aluminium, matte grained powder coating tinted beech wood or natural Alpi veneered beech wood.

#### Colors

Black, Brown-red

#### Origin

Europe

### TECHNICAL SPECIFICATIONS

Compliant with EN16139 for Contract use and stackable up to 6 pieces.

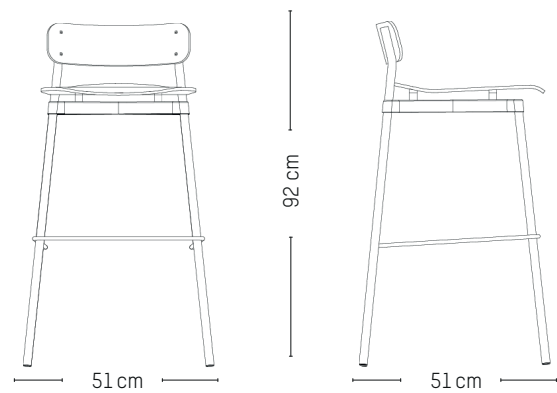

# FROMME

TOM CHUNG

2021



## Square table

-

### Materials





















Aluminium, matte grained Anti UV powder coating for outdoor use

### Colors

20 colors. RAL colors available with MOQ from our fine texture range (matt grained)

### Origin

China

 3012 BLUSH	 1016 YELLOW	 6019 PASTEL GREEN	 5002 BLUE	 7035 PEARL GREY
 8004 TERRACOTTA	 8000 GOLD	 6013 JADE GREEN	 5020 OCEAN BLUE	 DUNE
 2012 CORAL	 1015 IVORY	 6029 MINT GREEN	 5014 PIGEON BLUE	 9016 WHITE
 8012 BROWN RED	 1017 SAFFRON	 6007 GLASS GREEN	 5008 GREY BLUE	 9005 BLACK

47

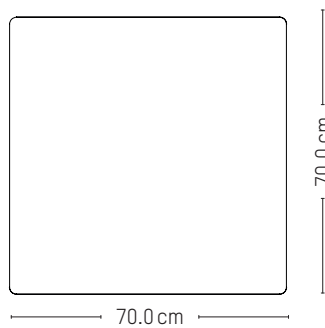
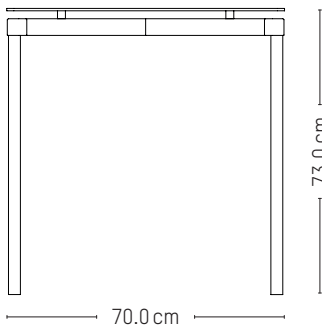

## Square table

-

**L:** 70.0 cm | 27.6 inches

**D:** 70.0 cm | 27.6 inches

**H:** 73.0 cm | 28.7 inches

**Weight:** 14.5 kg | 32.0 lb

### PACKAGING:

**L:** 88.0 cm | 34.6 inches

**W:** 77.0 cm | 30.3 inches

**H:** 20.0 cm | 7.9 inches

**Weight:** 18.0 kg | 39.7 lb



**Rectangular table**

**Materials**





















Aluminium, matte grained Anti UV powder coating for outdoor use

**Colors**

20 colors. RAL colors available with MOQ from our fine texture range (matt grained)

**Origin**

China

 3012 BLUSH	 1016 YELLOW	 6019 PASTEL GREEN	 5002 BLUE	 7035 PEARL GREY
 8004 TERRACOTTA	 8000 GOLD	 6013 JADE GREEN	 5020 OCEAN BLUE	 DUNE
 2012 CORAL	 1015 IVORY	 6029 MINT GREEN	 5014 PIGEON BLUE	 9016 WHITE
 8012 BROWN RED	 1017 SAFFRON	 6007 GLASS GREEN	 5008 GREY BLUE	 9005 BLACK

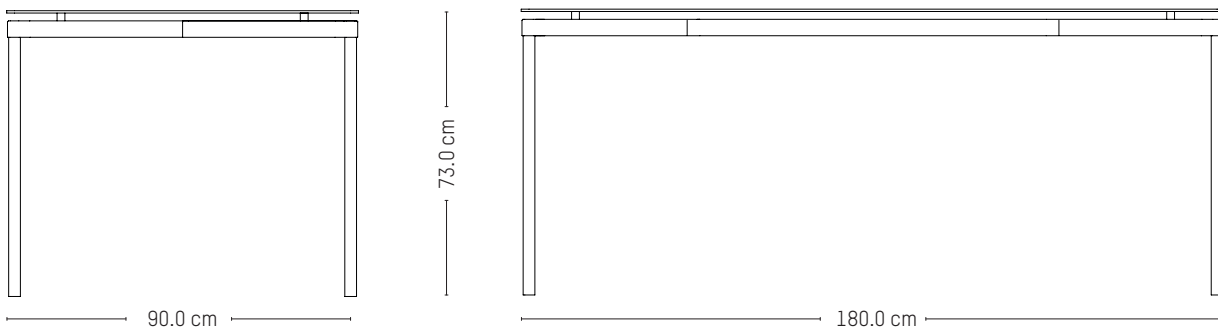

**Rectangular table**

**L:** 180.0 cm | 70.9 inches  
**W:** 90.0 cm | 35.4 inches  
**H:** 73.0 cm | 28.7 inches  
**Weight:** 37.5 kg | 82.7 lb

**PACKAGING:**

**Carton box 1:**  
**L:** 185.0 cm | 72.8 inches  
**W:** 95.0 cm | 37.4 inches  
**H:** 9.0 cm | 3.5 inches  
**Weight:** 34.0 kg | 75.0 lb

**Carton box 2:**  
**L:** 92.0 cm | 36.2 inches  
**W:** 72.0 cm | 28.3 inches  
**H:** 25.0 cm | 9.8 inches  
**Weight:** 12.0 kg | 26.5 lb



# FROMME

TOM CHUNG

2022



## Coffee table

-

### Materials





















Aluminium, matte grained Anti UV powder coating for outdoor use

### Colors

20 colors. RAL colors available with MOQ from our fine texture range (matt grained)

### Origin

China

 3012 BLUSH	 1016 YELLOW	 6019 PASTEL GREEN	 5002 BLUE	 7035 PEARL GREY
 8004 TERRACOTTA	 8000 GOLD	 6013 JADE GREEN	 5020 OCEAN BLUE	 DUNE
 2012 CORAL	 1015 IVORY	 6029 MINT GREEN	 5014 PIGEON BLUE	 9016 WHITE
 8012 BROWN RED	 1017 SAFFRON	 6007 GLASS GREEN	 5008 GREY BLUE	 9005 BLACK

49

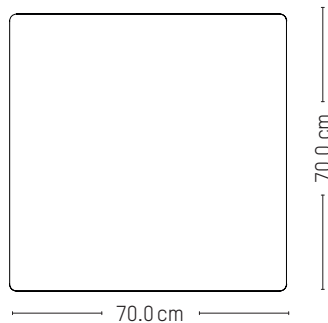
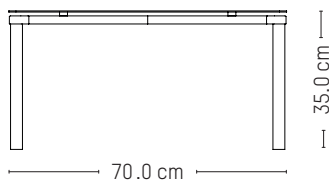

## Coffee table

-

**L:** 70.0 cm | 27.6 inches

**W:** 70.0 cm | 27.6 inches

**H:** 35.0 cm | 13.8 inches

**Weight:** 12.0 kg | 26.5 lb

### PACKAGING:

**L:** 88.0 cm | 34.6 inches

**W:** 77.0 cm | 30.3 inches

**H:** 20.0 cm | 7.9 inches

**Weight:** 16.0 kg | 35.3 lb

# UPHOLSTERY



**LILY**

FÄRG & BLANCHE

2022



## Sofa and armchair

### Materials

Steel frame and ply wood, steel springs, 100% polyurethane fireproof HR foam.

### Colors

4 collections of fabric available.  
See our upholstery collections brochure.

### Origin

Europe

### TECHNICAL SPECIFICATIONS

Lily armchairs and sofas are manufactured to order.  
8 to 12 weeks production time.

52

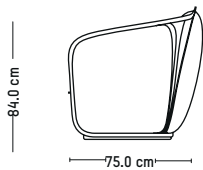
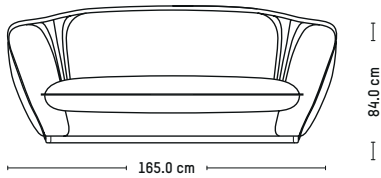

## Sofa

**L:** 165.0 cm | 65 inches  
**W:** 75.0 cm | 29.5 inches  
**H:** 84.0 cm | 33.1 inches  
**Weight:** 59.0 kg | 130.1 lb

### PACKAGING:

**L:** 172.0 cm | 67.7 inches  
**W:** 85.0 cm | 33.5 inches  
**H:** 102.0 cm | 40.2 inches  
**Weight:** 90.0 kg | 198.4 lb

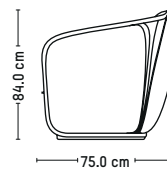
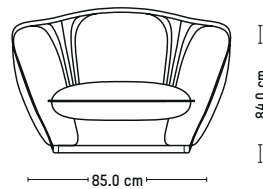

## Armchair

**L:** 85.0 cm | 33.5 inches  
**W:** 75.0 cm | 29.5 inches  
**H:** 84.0 cm | 33.1 inches  
**Weight:** 39.0 kg | 86.0 lb

### PACKAGING:

**L:** 92.0 cm | 36.2 inches  
**W:** 85.0 cm | 33.5 inches  
**H:** 102.0 cm | 40.2 inches  
**Weight:** 60.0 kg | 132.3 lb

# GRID

## STUDIO POOL

2016



### Sofa and armchair

#### Materials

Steel with matte grained powder coating + oak wood  
**Seat and back:** 100% PU foam 80g/m<sup>2</sup>  
 Cushion in mix of PU and wadding, fabric to be chosen by client

Origin  
 Europe

#### TECHNICAL SPECIFICATIONS

Removable cushions



53

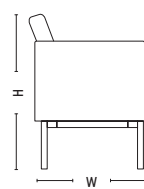
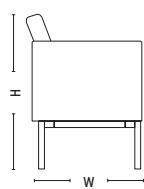
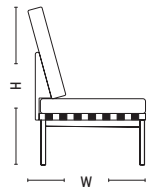
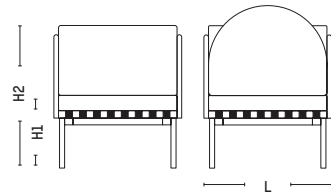
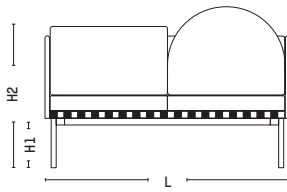
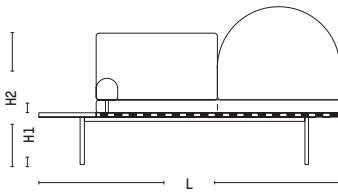

### Daybed

**L:** 187.0 cm | 73.6 inches  
**W:** 71.0 cm | 28.0 inches  
**H:** 92.0 cm | 36.2 inches  
**H1:** 45.0 cm | 17.7 inches  
**Weight:** 45.0 kg | 99.2 lb

#### PACKAGING:

**L:** 170.0 cm | 66.9 inches  
**W:** 90.0 cm | 35.4 inches  
**H:** 100.0 cm | 39.4 inches  
**Weight:** 90.0 kg | 198.4 lb

Options: round cushion,  
 square cushion, headrest,  
 walnut wood

### Sofa with 2 armrests

**L:** 146.0 cm | 57.5 inches  
**W:** 71.0 cm | 28.0 inches  
**H:** 92.0 cm | 36.2 inches  
**H1:** 45.0 cm | 17.7 inches  
**H2:** 86.0 cm | 33.9 inches  
**Weight:** 50.0 kg | 110.2 lb

#### PACKAGING:

**L:** 170.0 cm | 66.9 inches  
**W:** 90.0 cm | 35.4 inches  
**H:** 100.0 cm | 39.4 inches  
**Weight:** 95.0 kg | 209.4 lb

Options: round cushion,  
 square cushion, walnut wood  
 1 or 2 armrest

### Armchair with 2 armrests

**L:** 76.0 cm | 29.9 inches  
**W:** 71.0 cm | 28.0 inches  
**H:** 93.0 cm | 36.6 inches  
**H1:** 45.0 cm | 17.7 inches  
**H2:** 86.0 cm | 33.9 inches  
**Weight:** 34.0 kg | 75.0 lb

#### PACKAGING:

**L:** 90.0 cm | 35.4 inches  
**W:** 88.0 cm | 34.6 inches  
**H:** 100.0 cm | 39.4 inches  
**Weight:** 70.0 kg | 154.3 lb

Options: round cushion,  
 square cushion, walnut wood  
 1 or 2 armrest

# GRID

## STUDIO POOL

2016



### Stool and coffee table

-

#### Materials

Steel with matte grained powder coating + oak wood

**Seat and back:** 100% PU foam 80g/m<sup>2</sup>

Cushion in mix of PU and wadding, fabric to be chosen by client

#### Origin

Europe

#### TECHNICAL SPECIFICATIONS

Removable cushions

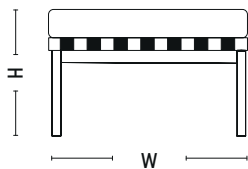

### Stool

-

**L:** 68.0 cm | 26.8 inches

**W:** 68.0 cm | 26.8 inches

**H:** 45.0 cm | 17.7 inches

**Weight:** 17.0 kg | 37.5 lb

PACKAGING:

**Type:** Wood box

**L:** 90.0 cm | 35.4 inches

**W:** 88.0 cm | 34.6 inches

**H:** 100.0 cm | 39.4 inches

**Weight:** 55.0 kg | 121.3 lb

Options: walnut wood

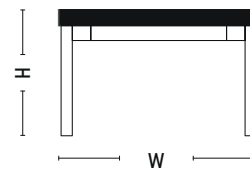

### Coffee table

-

**L:** 68.0 cm | 26.8 inches

**W:** 68.0 cm | 26.8 inches

**H:** 33.0 cm | 13.0 inches

**Weight:** 21.0 kg | 46.3 lb

PACKAGING:

**Type:** Wood box

**L:** 90.0 cm | 35.4 inches

**W:** 88.0 cm | 34.6 inches

**H:** 100.0 cm | 39.4 inches

**Weight:** 60.0 kg | 132.3 lb

Options: walnut wood

# GRID - PRE-COMPOSED FABRIC SELECTION

## SELECTED FABRICS

### 1/ CHOOSE MODULES

### 2/ FABRICS: SHADES OF GREY

#### Grey-black



Base  
Cat.2  
FIELD 2 - 182



Round cushion  
Cat.2  
VITA NOIR ITA12



Headrest  
Cat.2  
VITA NOIR ITA12

#### Grey-blue



Base  
Cat.3  
FIELD 2 - 222



Round cushion  
Cat.2  
VITA SWAN ITA42



Headrest  
Cat.2  
VITA SWAN ITA42

#### Grey-beige



Base  
Cat.3  
FIELD 2 - 123



Round cushion  
Cat.2  
VITA ALPACA ITA46



Headrest  
Cat.2  
VITA ALPACA ITA46

### 3/ WOOD, METAL AND OPTIONS



Oak Wood  
already included



**EXAMPLES OF MODULAR ASSEMBLY: GRID modules allow to create multiple configurations to equip entire lounge spaces.**



**2 seater sofa without armrest  
+ armchair without armrest**

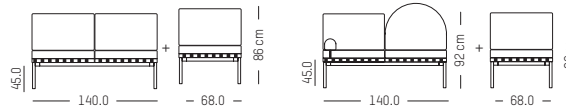

**2 seater sofa without armrest  
+ armchair with 1 armrest**

*(right or left)*

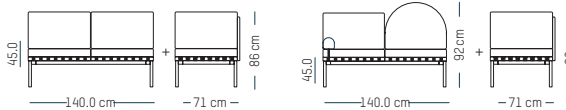

**2 seater sofa without armrest  
+ 2 armchairs with 1 armrest**

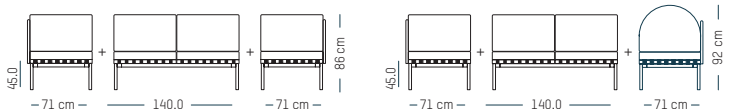

**2 seater sofa without armrest  
+ 1 armchair with 1 armrest + 1 pouf**

*(right or left)*

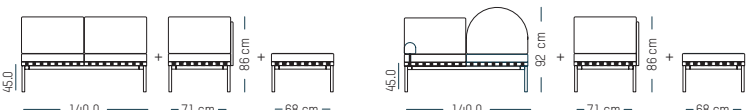





**Armchairs and Stools**

**Materials**

Steel with matte grained powder coating  
**Seat and back:** PU foam 40kg/m<sup>3</sup> + wadding 100% PE 80g/m<sup>2</sup>  
**Cover:** fabric to be chosen by client (non removable covers).

Origin  
 Europe

**TECHNICAL SPECIFICATIONS**

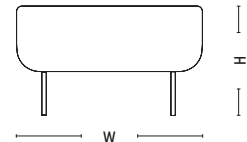
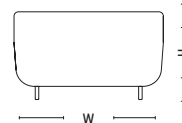
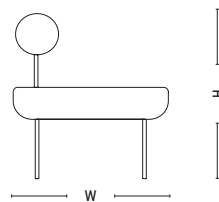
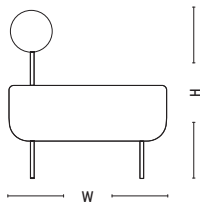
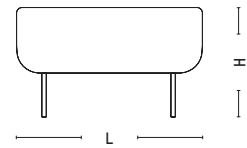
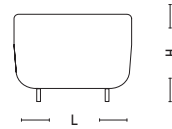
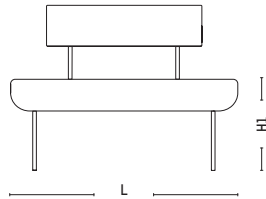
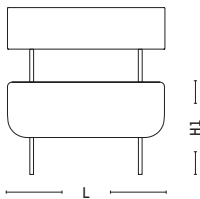

**Medium Armchair**

**L:** 68.0 cm | 26.8 inches  
**W:** 68.0 cm | 26.8 inches  
**H:** 72.5 cm | 28.5 inches  
**H1:** 40.0 cm | 15.7 inches  
**Weight:** 17.0 kg | 37.5 lb

**PACKAGING:**

**Type:** Wood box  
**L:** 80.0 cm | 31.5 inches  
**W:** 120.0 cm | 47.2 inches  
**H:** 85.0 cm | 33.5 inches  
**Weight:** 24.0 kg | 52.9 lb

**Large Armchair**

**L:** 99.5 cm | 39.2 inches  
**W:** 68.0 cm | 26.8 inches  
**H:** 72.5 cm | 28.5 inches  
**H1:** 40.0 cm | 15.7 inches  
**Weight:** 18.0 kg | 39.7 lb

**PACKAGING:**

**Type:** Wood box  
**L:** 80.0 cm | 31.5 inches  
**W:** 120.0 cm | 47.2 inches  
**H:** 75.0 cm | 29.5 inches  
**Weight:** 31.0 kg | 68.3 lb

**Small Stool**

**L:** 50.0 cm | 19.7 inches  
**W:** 68.0 cm | 26.8 inches  
**H:** 40.0 cm | 15.7 inches  
**Weight:** 14.0 kg | 30.9 lb

**PACKAGING:**

**Type:** Wood box  
**L:** 80.0 cm | 31.5 inches  
**W:** 120.0 cm | 47.2 inches  
**H:** 60.0 cm | 23.6 inches  
**Weight:** 24.0 kg | 52.9 lb

**Medium Stool**

**L:** 68.0 cm | 26.8 inches  
**W:** 68.0 cm | 26.8 inches  
**H:** 40.0 cm | 15.7 inches  
**Weight:** 14.5 kg | 32.0 lb

**PACKAGING:**

**Type:** Wood box  
**L:** 80.0 cm | 31.5 inches  
**W:** 120.0 cm | 47.2 inches  
**H:** 50.0 cm | 19.7 inches  
**Weight:** 25.0 kg | 55.1 lb

# HOFF - PRE-COMPOSED FABRIC SELECTION

## SELECTED FABRICS

### 1/ CHOOSE MODULES

### 2/ FABRICS: SHADES OF GREY

#### Grey-black

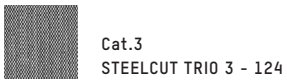

#### Grey-blue



#### Grey-beige



STEELCUT TRIO 3 - 124 / FIELD 2 - 182



STEELCUT TRIO 3 - 205 / FIELD 2 - 222



STEELCUT TRIO 3 - 616 / FIELD 2 - 123



FIELD 2 - 182 / SAVOY 60198



FIELD 2 - 222 / SAVOY 66165



FIELD 2 - 123 / SAVOY 61221



SAVOY 60198



SAVOY 66165



SAVOY 61221



STEELCUT TRIO 3 - 124



STEELCUT TRIO 3 - 205



STEELCUT TRIO 3 - 616

# **CUSTOMISE**

**MAKE YOUR OWN CUSTOM  
LILY, GRID, HOFF  
SOFAS, ARMCHAIRS & STOOLS**

**Find in the next pages, a selection of fabrics that are suitable for our range of sofas and armchairs.**

**For other fabrics (COM), please contact us for price and lead time.**

# FABRICS' SELECTIONS

TO CREATE YOUR CUSTOM LILY, GRID & HOFF SOFAS, ARMCHAIRS, STOOLS

## CATEGORY 1

GABRIEL CHILI | GABRIEL RHYTHM | GABRIEL RONDO

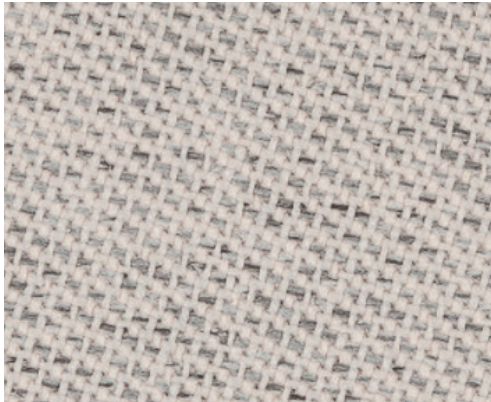

### 1A. GABRIEL CHILI

**MATERIAL:** 100% post-consumer recycled polyester fr  
*Width: 140cm - 55in*  
*Weight: 470g/ml - 16.60z/Lin.yd*

**DURABILITY:** 60.000 Martindale  
**ENVIRONMENT:** STANDARD 100 by OEKO-TEX®

**FIRE STANDARDS:** BS EN 1021 1&2  
 Cigarette and Match/ BS EN 1021-1  
 Cigarette  
 BS 7176 Medium hazard/ BS 5852 Crib 5  
 BS 5852 Crib 5 / Call 117

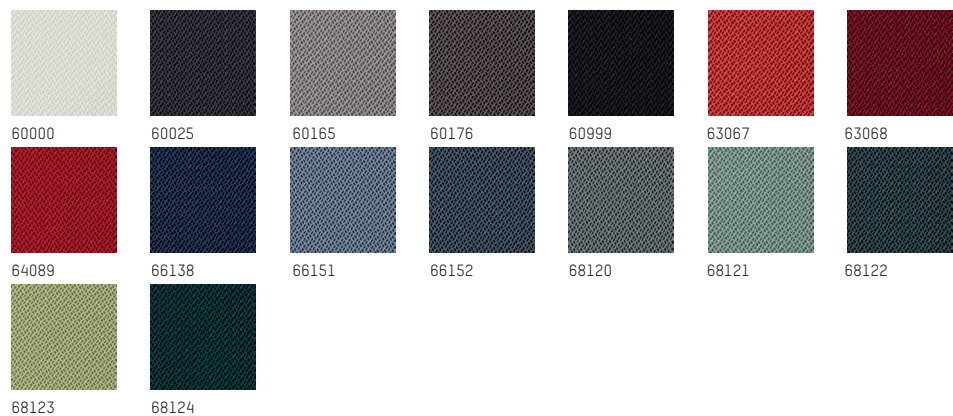

### 1B. GABRIEL RHYTHM

**MATERIAL:** 100% polyester/polyester  
 flame retardant  
*Width: 140cm - 55in*  
*Weight: 490g/ml - 17.240z/Lin.yd*

**DURABILITY:** 70.000 Martindale  
**ENVIRONMENT:** STANDARD 100 by OEKO-TEX®

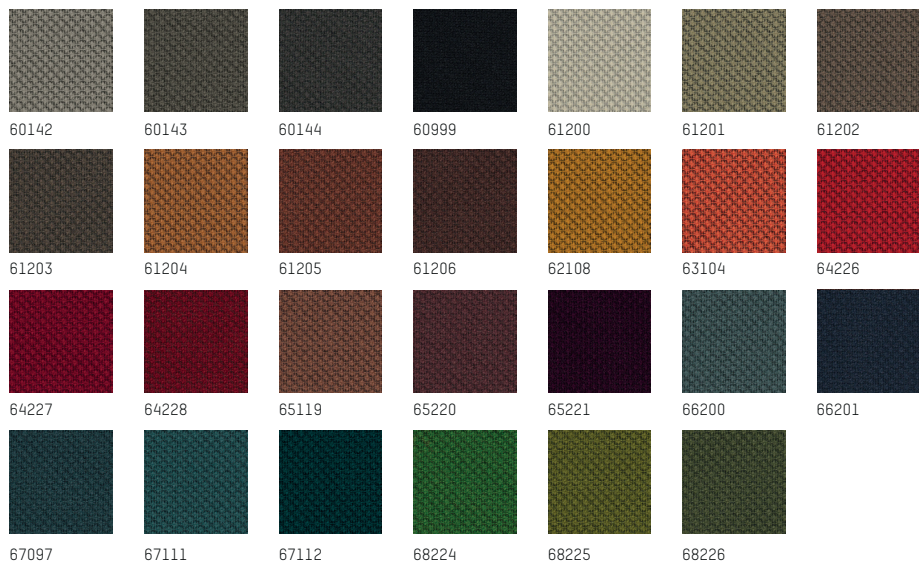

**1C. GABRIEL RONDO**

**MATERIAL:** 100% post-consumer recycled polyester fr  
 Width: 140cm - 55in  
 Weight: 470g/ml - 16.60z/Lin.yd

**DURABILITY:** 60.000 Martindale  
**ENVIRONMENT:** STANDARD 100 by OEKO-TEX®  
**FIRE STANDARDS:** BS EN 1021 1&2 Cigarette and Match/ BS EN 1021-1 Cigarette and Match/ BS 5852 Crib 5 / BS 5852 Crib 5 / Call 117

**CATEGORY 2**

CAMIRA - VITA | GABRIEL FAME + FAME HYBRIDE | GABRIEL - CRISP | KVADRAT - FIELD 2  
 GABRIEL FOCUS + FOCUS MELANGE

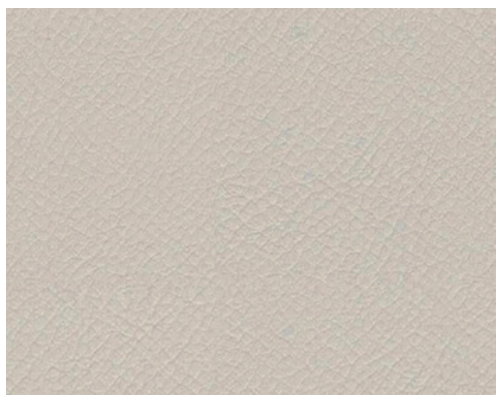

**2A. CAMIRA - VITA**

**MATERIAL:** Surface: 98% PVC, 2% PU  
 Substrate: 100% Cotton  
 Width: 140cm - 55in  
 Weight: 850g/ml - 29.980z/Lin.yd  
**DURABILITY:** 100.000 turns  
**ENVIRONMENT:** Phthalate free  
**FIRE STANDARDS:** EN 1021-1 (cigarette)  
 EN 1021-2 (match) / BS 7176 Low Hazard  
 BS 5852 Ignition Source 5 :BS 7176 Medium Hazard /BS 5852 Ignition Source 7 (with interliner)

# FABRICS' SELECTIONS

TO CREATE YOUR CUSTOM LILY, GRID & HOFF SOFAS, ARMCHAIRS, STOOLS

## CATEGORY 2

CAMIRA – VITA | GABRIEL FAME + FAME HYBRIDE | GABRIEL – CRISP | KVADRAT – FIELD 2  
GABRIEL FOCUS + FOCUS MELANGE

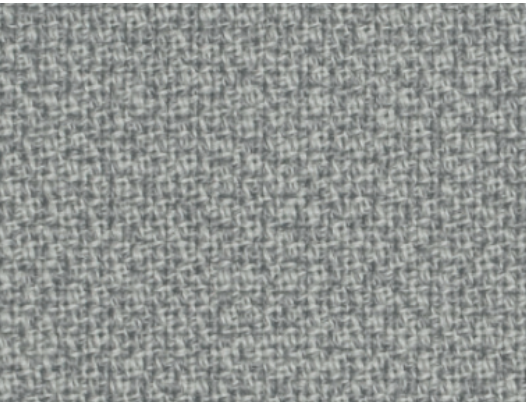

### 2B. GABRIEL FAME + FAME HYBRIDE

**MATERIAL:** 95% New Zealand wool  
/ 5% polyamide  
**Width:** 140cm – 55in  
**Weight:** 630g/ml – 22.220z/Lin.yd

**DURABILITY:** 150.000 Martindale  
**ENVIRONMENT:** STANDARD 100 by OEKO-TEX®  
**FIRE STANDARDS:** BS EN 1021 1&2 Cigarette  
and Match/ BS EN 1021-1 Cigarette  
BS 7176 Medium hazard/ BS 5852 Crib 5  
BS 5852 Crib 5 / Call 117

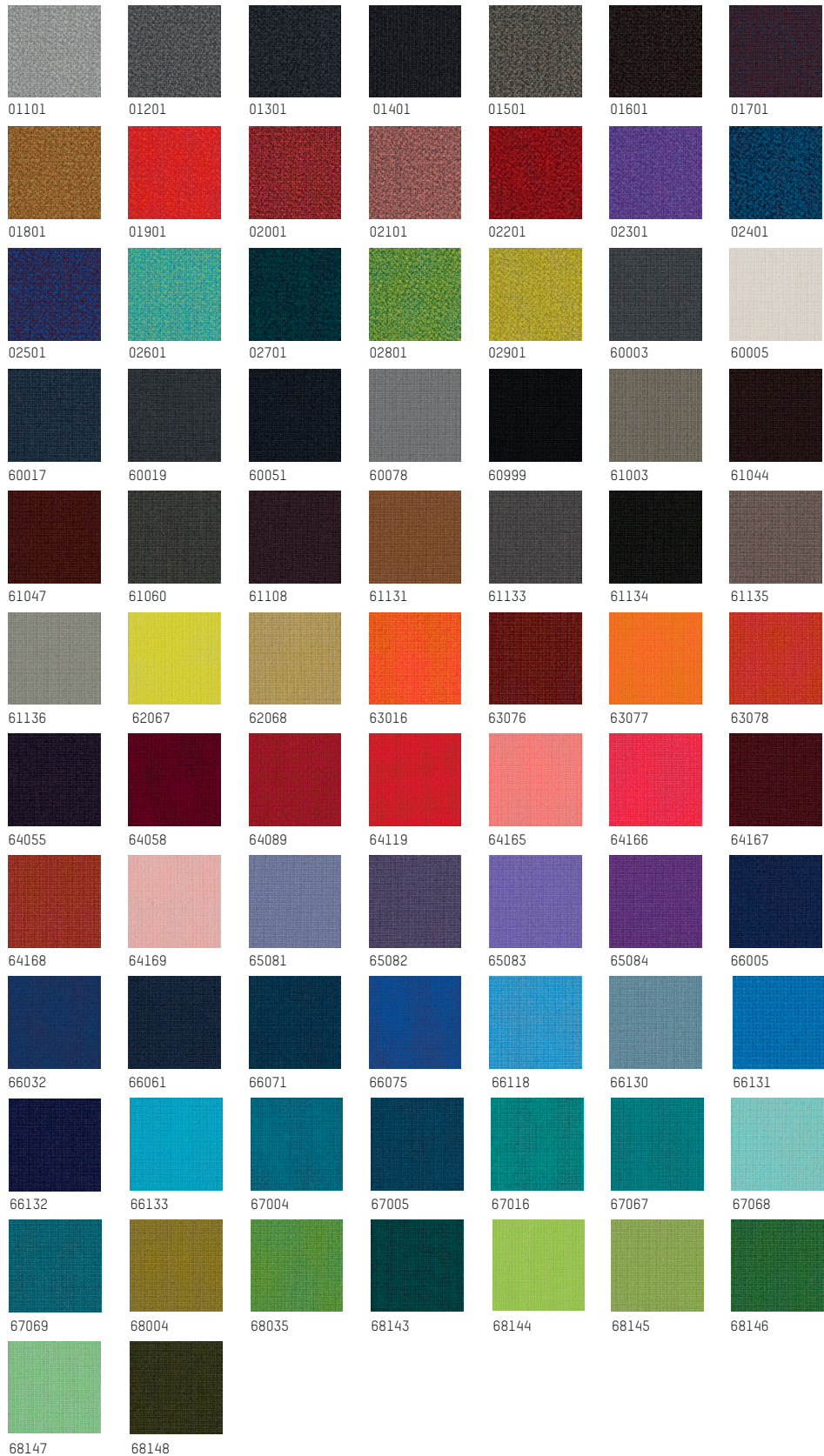

# FABRICS' SELECTIONS

TO CREATE YOUR CUSTOM LILY, GRID & HOFF SOFAS, ARMCHAIRS, STOOLS

## CATEGORY 2

CAMIRA – VITA | GABRIEL FAME + FAME HYBRIDE | GABRIEL – CRISP | KVADRAT – FIELD 2  
GABRIEL FOCUS + FOCUS MELANGE



### 2C. GABRIEL – CRISP

**MATERIAL:** 93% New Zealand wool  
/ 7% polyamide  
Width: 140cm – 55in  
Weight: 460g/ml – 16.230z/Lin.yd

**DURABILITY:** 200.000 Martindale  
**ENVIRONMENT:** STANDARD 100 by OEKO-TEX®  
/ EU Ecolabel  
**FIRE STANDARDS:** BS EN 1021 1&2 Cigarette  
and Match/ BS EN 1021-1 Cigarette  
BS 7176 Medium hazard/ BS 5852 Crib 5  
BS 5852 Crib 5 / Call 117

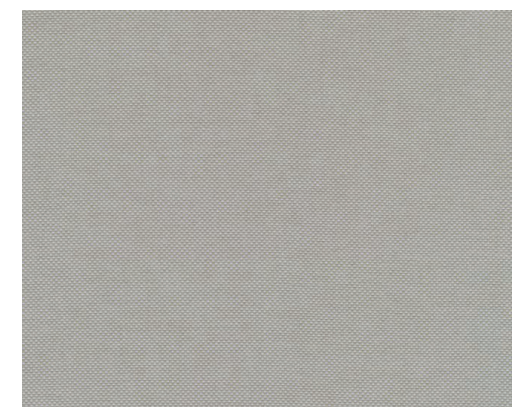
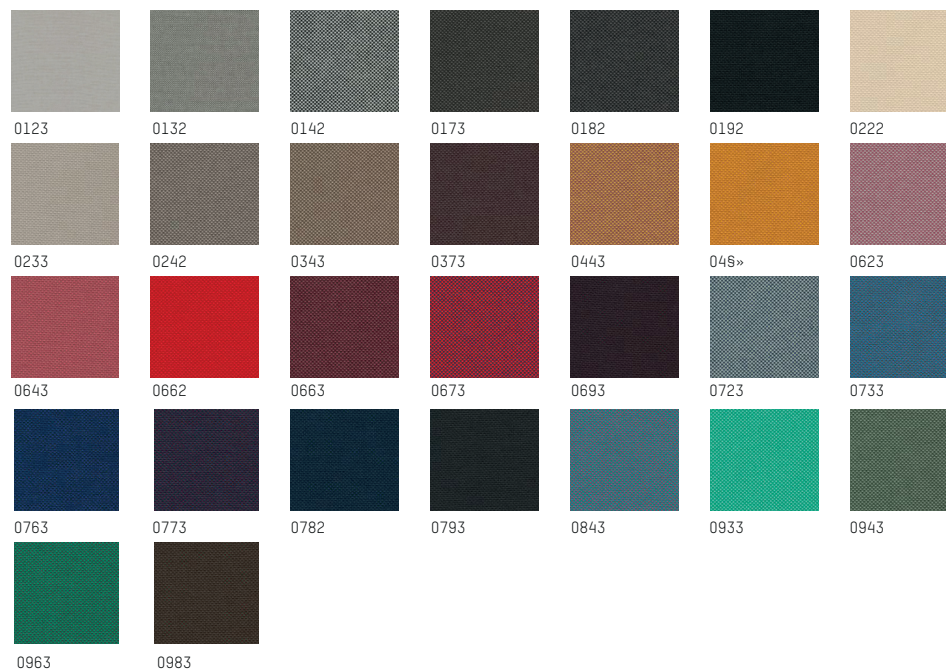

### 2D. KVADRAT – FIELD 2

**MATERIAL:** 100% Trevira CS  
Width: 140cm – 55in  
Weight: 450g/ml – 15.870z/Lin.yd

**DURABILITY:** 80.000 Martindale  
**ENVIRONMENT:** EU Ecolabel, Greenguard  
Gold, HPD, EPD  
**FIRE STANDARDS:** BS 5852 Crib 5  
EN 1021-1/2 / EN 13501-1 B-s1. d0

# FABRICS' SELECTIONS

TO CREATE YOUR CUSTOM LILY, GRID & HOFF SOFAS, ARMCHAIRS, STOOLS

## CATEGORY 2

CAMIRA - VITA | GABRIEL FAME + FAME HYBRIDE | GABRIEL - CRISP | KVADRAT - FIELD 2  
GABRIEL FOCUS + FOCUS MELANGE

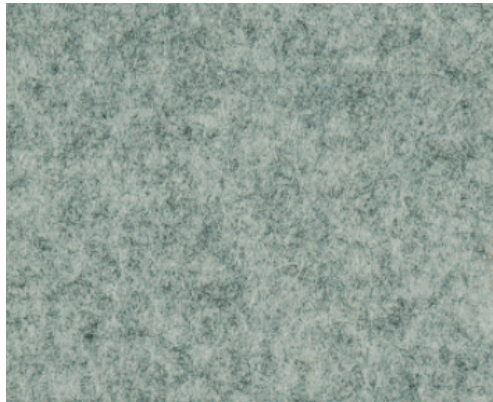

### 2E. GABRIEL FOCUS + FOCUS MÉLANGE

**MATERIAL:** 100% New Zealand wool  
*Width: 140cm - 55in*  
*Weight: 660g/ml - 23.280z/Lin.yd*

**DURABILITY:** 100.000 Martindale  
**ENVIRONMENT:** STANDARD 100 by OEKO-TEX®  
/ EU Ecolabel  
**FIRE STANDARDS:** BS EN 1021 1&2 Cigarette  
and Match/ BS 5852 Part 1 0.1 Cigarette  
& match





# FABRICS' SELECTIONS

TO CREATE YOUR CUSTOM LILY, GRID & HOFF SOFAS, ARMCHAIRS, STOOLS

## CATEGORY 3

CAMIRA - OCEANIC | GABRIEL - SAVOY | KVADRAT - CLAY - SAHCO | KVADRAT - STEELCUT 2 | KVADRAT - STEELCUT TRIO 3 | KVADRAT- ENCIRCLE

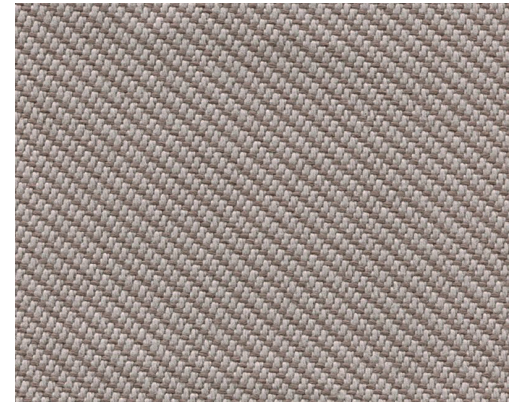
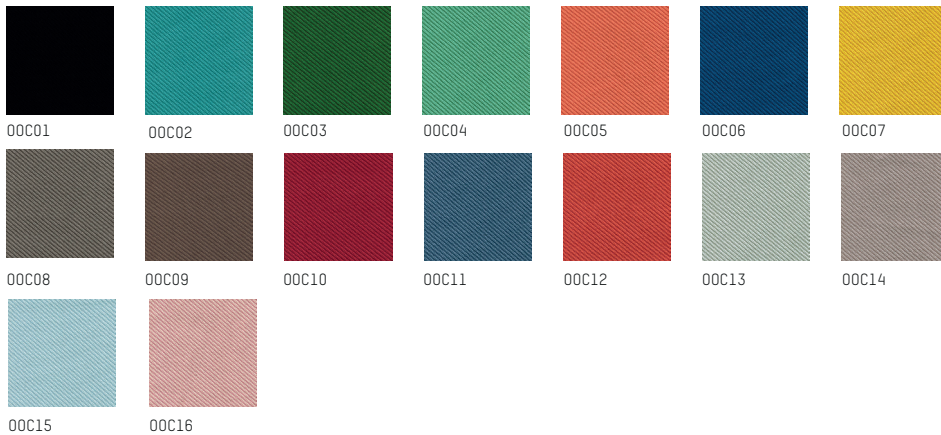

### 3A. CAMIRA - OCEANIC

**MATERIAL:** 100% post-consumer recycled polyester, including 50% SEAQUAL yarn.  
*Width: 140cm - 55in*  
*Weight: 497g/ml - 17.530z/Lin.yd*

**DURABILITY:** 135.000 Martindale  
**ENVIRONMENT:** S EKO-TEX® Standard 100 / Certified to Indoor Advantage™ «Gold» / Made from 100% post-consumer recycled polyester / Non metallic dyestuffs.  
**FIRE STANDARDS:** EN 1021 - 1 (cigarette) / EN 1021 - 2 (match) / BS 7176 Low Hazard / BS 5852 Ignition Source 5 with EnviroFlam5 / BS 7176 Medium Hazard with EnviroFlam5

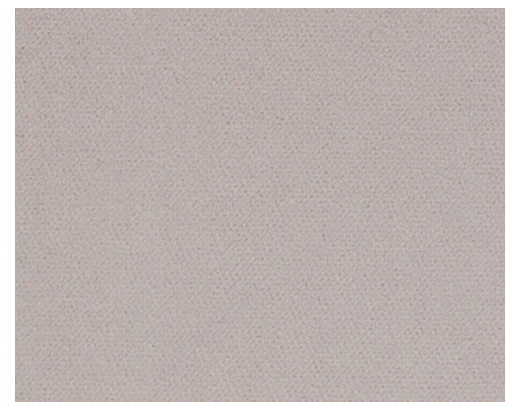

### 3B. GABRIEL - SAVOY

**MATERIAL:** 100% Trevira CS  
*Width: 140cm - 55in*  
*Weight: 600g/ml - 21.160z/Lin.yd*

**DURABILITY:** 100.000 Martindale  
**ENVIRONMENT:** STANDARD 100 by OEKO-TEX® / EU Ecolabel  
**FIRE STANDARDS:** BS 5852 Crib 5  
 EN 1021-1/2 / EN 13501-1 B-s1. d0

# FABRICS' SELECTIONS

TO CREATE YOUR CUSTOM LILY, GRID & HOFF SOFAS, ARMCHAIRS, STOOLS

## CATEGORY 3

CAMIRA - OCEANIC | GABRIEL - SAVOY | KVADRAT - CLAY - SAHCO | KVADRAT - STEELCUT 2 | KVADRAT - STEELCUT TRIO 3 | KVADRAT- ENCIRCLE



### 3C. KVADRAT - CLAY - SAHCO

**MATERIAL:** 76% linen, 21% cotton, 3% polyester  
*Width: 140cm - 55in*  
*Weight: 768g/ml - 27.09oz/Lin.yd*

**DURABILITY:** 45.000 Martindale  
**ENVIRONMENT:** GREENGUARD GOLD, HPD,  
**EPD FIRE STANDARDS:** BS 5852 source 0 / 1. EN 1021-1 / 2 With flame retardant treatment: BS 5852 source 5.

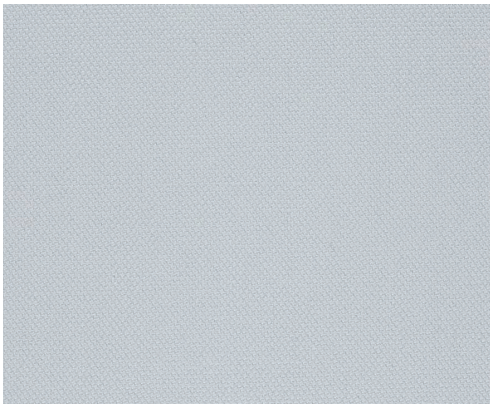

### 3D. KVADRAT - STEELCUT 2

**MATERIAL:** 90% new wool worsted 10% nylon  
*Width: 175cm - 69in*  
*Weight: 825g/ml - 29.10oz/Lin.yd*

**DURABILITY:** 100.000 Martindale  
**ENVIRONMENT:** EU Ecolabel, Greenguard Gold, HPD, EPD  
**FIRE STANDARDS:** BS 5852 part 1 EN 1021-1/2  
 BS 5852 crib 5 with treatment \*  
 SN 198 898 5.3 with treatment \*

# FABRICS' SELECTIONS

TO CREATE YOUR CUSTOM LILY, GRID & HOFF SOFAS, ARMCHAIRS, STOOLS

## CATEGORY 3

CAMIRA - OCEANIC | GABRIEL - SAVOY | KVADRAT - CLAY - SAHCO | KVADRAT  
- STEELCUT 2 | KVADRAT - STEELCUT TRIO 3 | KVADRAT- ENCIRCLE

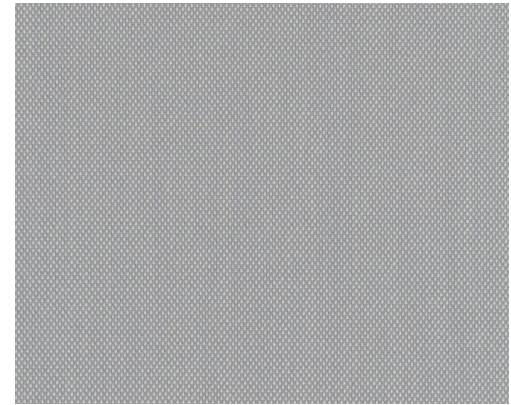

### 3E. KVADRAT - STEELCUT TRIO 3

**MATERIAL:** 90% new wool worsted 10% nylon  
Width: 140cm - 55in  
Weight: 770g/ml - 27.160z/Lin.yd

**DURABILITY:** 100.000 Martindale  
**ENVIRONMENT:** EU Ecolabel, Greenguard Gold,  
HPD, EPD

**FIRE STANDARDS:** EN 1021-1/2  
BS 5852 part 1/ BS Crib 5  
With flame retardant treatment.

# FABRICS' SELECTIONS

TO CREATE YOUR CUSTOM LILY, GRID & HOFF SOFAS, ARMCHAIRS, STOOLS

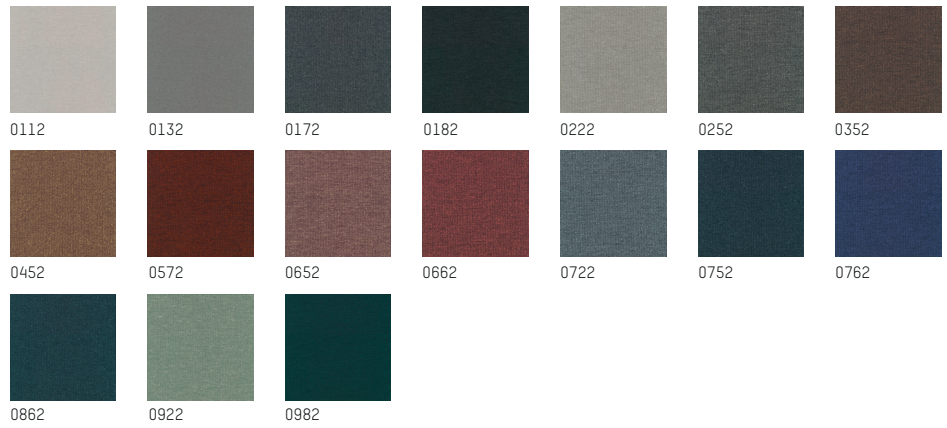
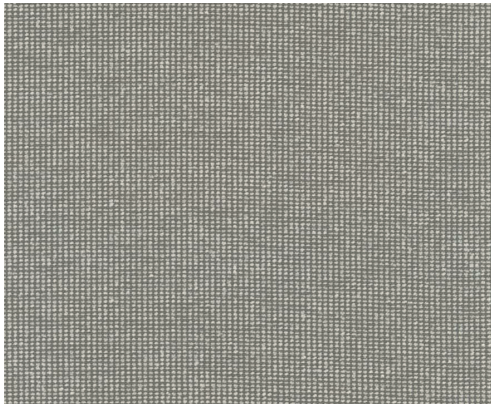

## 36. KVADRAT - ENCIRCLE

**MATERIAL:** 76% linen, 21% cotton, 3% polyester  
*Width: 140cm - 55in*  
*Weight: 768g/ml - 27.09oz/Lin.yd*

**DURABILITY:** 45.000 Martindale  
**ENVIRONMENT:** GREENGUARD GOLD, HPD,  
**EPD FIRE STANDARDS:** BS 5852 source 0 / 1. EN 1021-1 / 2 With flame retardant treatment: BS 5852 source 5.



# FABRICS' SELECTIONS

TO CREATE YOUR CUSTOM LILY, GRID & HOFF SOFAS, ARMCHAIRS, STOOLS

## CATEGORY 4

KVADRAT - MOSS | KVADRAT - FOSS | KVADRAT - COMFORT+ | KVADRAT - MOLLY 2



### 4A. KVADRAT - MOSS

**MATERIAL:** 100% post-consumer recycled polyester fr  
 Width: 140cm - 55in  
 Weight: 470g/ml - 16.60z/Lin.yd

**DURABILITY:** 60.000 Martindale  
**ENVIRONMENT:** STANDARD 100 by OEKO-TEX®  
**FIRE STANDARDS:** BS EN 1021 1&2 Cigarette and Match / BS EN 1021-1 Cigarette BS 7176 Medium hazard / BS 5852 Crib 5 BS 5852 Crib 5 / Call 117



### 4B. KVADRAT - FOSS

**MATERIAL:** 76% new wool worsted 11% viscose 8% nylon 5% linen  
 Width: 145cm - 57in  
 Weight: 500g/ml - 17.640z/Lin.yd

**DURABILITY:** 100.000 Martindale  
**ENVIRONMENT:** EU Ecolabel, Greenguard Gold, HPD, EPD  
**FIRE STANDARDS:** BS 5852 part 1 EN 1021-1/2 BS 5852 crib 5 with treatment \*

# FABRICS' SELECTIONS

TO CREATE YOUR CUSTOM LILY, GRID & HOFF SOFAS, ARMCHAIRS, STOOLS

## CATEGORY 4

KVADRAT - MOSS | KVADRAT - FOSS | KVADRAT - COMFORT+ | KVADRAT - MOLLY 2



### 4C. KVADRAT - COMFORT +

**MATERIAL:** 78% polyester/12% polyurethane incl. antistatic fibers and fire retardant fibers in the backside  
**Width:** 140cm - 55in  
**Weight:** 385g/ml - 13.580z/Lin.yd

**DURABILITY:** 150.000 Martindale  
**ENVIRONMENT:** STANDARD 100 by OEKO-TEX®

**FIRE STANDARDS:** BS EN 1021 1&2 Cigarette and Match / BS EN 1021-1 Cigarette

00004	00005	00010	00018	00026	00028	00029
00033	00034	00035	00040	00049	00050	00280
01012	01043	01049	01065	01124	01147	01153
01160	01161	01163	01167	01414	01566	08384
08397	08402	08422	09055	09074	09075	09084
60002	60003	60004	60005	60008	60009	61002
61003	61013	61014	61015	61016	61018	62003
62004	62005	63001	63006	64001	64002	64003
64009	64012	64013	64014	65003	65012	66002
66004	66005	66008	66010	67001	67002	68000
68001	68003	68007	68008	68009	68010	68011

# FABRICS' SELECTIONS

TO CREATE YOUR CUSTOM LILY, GRID & HOFF SOFAS, ARMCHAIRS, STOOLS

## CATEGORY 4

KVADRAT - MOSS | KVADRAT - FOSS | KVADRAT - COMFORT+ | KVADRAT - MOLLY 2



### 4D. KVADRAT - MOLLY 2

**MATERIAL:** 100% new wool worsted  
 Width: 140cm - 55in  
 Weight: 610g/ml - 21.52Oz/Lin.yd

**DURABILITY:** 75.000 Martindale  
**ENVIRONMENT:** EU Ecolabel, Greenguard Gold, HPD, Only natural color wool  
**FIRE STANDARDS:** BS 5852 part 1 EN 1021 - 1/2  
 BS 5852 crib 5 with treatment \*

## CATEGORY 5

KVADRAT - VIDAR 4 | KVADRAT - BARU | SOVOS - LEATHER | KVADRAT - SAPHIRE



### 5A. KVADRAT - VIDAR 4

**MATERIAL:** 94% new wool 6% nylon  
 Width: 140cm - 55in  
 Weight: 765g/ml - 26.98 Oz/Lin.yd

**DURABILITY:** 100.000 Martindale  
**ENVIRONMENT:** EU Ecolabel, Greenguard Gold, HPD, EPD  
**FIRE STANDARDS:** BS 5852 part 1 EN 1021 - 1/2  
 BS 5852 crib 5 with treatment \*

# FABRICS' SELECTIONS

TO CREATE YOUR CUSTOM LILY, GRID & HOFF SOFAS, ARMCHAIRS, STOOLS

## CATEGORY 5

KVADRAT - VIDAR 4 | KVADRAT - BARU | SOVOS - LEATHER | KVADRAT - SAPHIRE

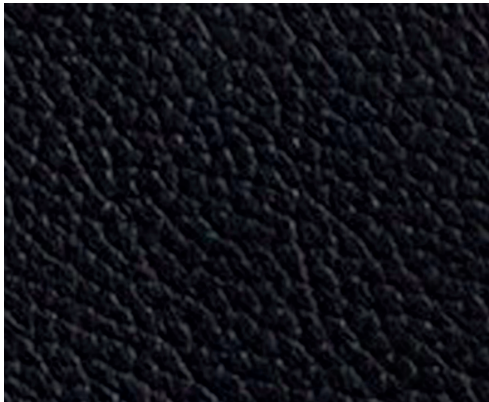

### 5B. SOVOS - LEATHER

**MATERIAL:** 76% linen, 21% cotton, 3% polyester  
 Width: 140cm - 55in  
 Weight: 768g/ml - 27.09oz/Lin.yd

**DURABILITY:** 45.000 Martindale  
**ENVIRONMENT:** GREENGUARD GOLD, HPD, EPD  
**FIRE STANDARDS:** BS 5852 source 0 / 1. EN 1021-1 / 2 With flame retardant treatment: BS 5852 source 5.

72

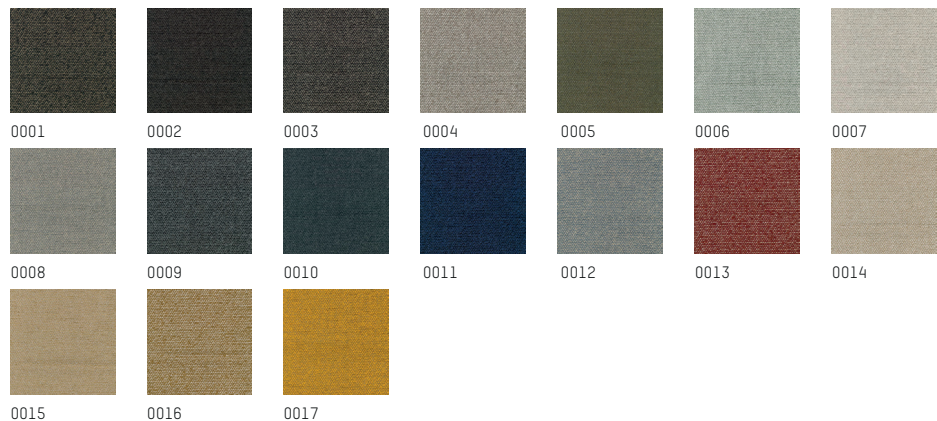
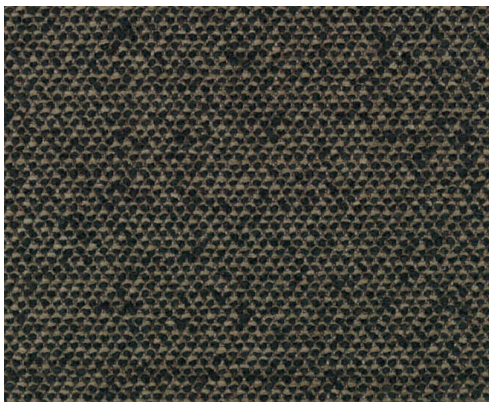

### 5C. KVADRAT - SAPHIRE

**MATERIAL:** 43% viscose 17% polyacrylic 15% new wool 9% cotton 8% polyester 8% linen  
 Width: 140cm - 55in  
 Weight: 1010g/ml - 35.63oz/Lin.yd

**DURABILITY:** 44.000 Martindale  
**ENVIRONMENT:** Greenguard Gold, HPD EPD  
**FIRE STANDARDS:** BS 5852 source 0 / 1 EN 1021-1 / 2 With flame retardant treatment: BS 5852 source 5

72



# FABRICS' SELECTIONS

TO CREATE YOUR CUSTOM LILY, GRID & HOFF SOFAS, ARMCHAIRS, STOOLS

## CATEGORY 5

KVADRAT - VIDAR 4 | KVADRAT - BARU | SOVOS - LEATHER | KVADRAT - SAPHIRE

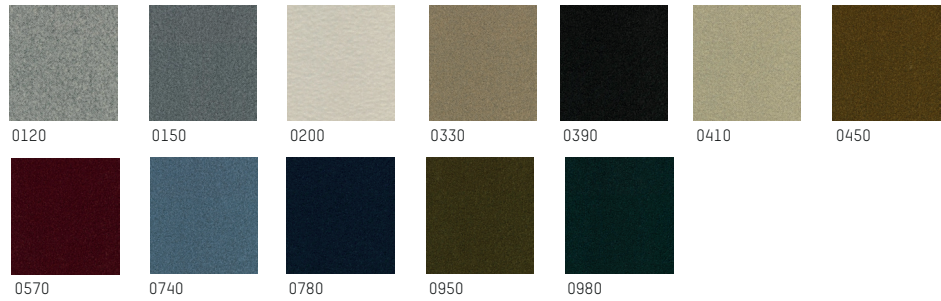
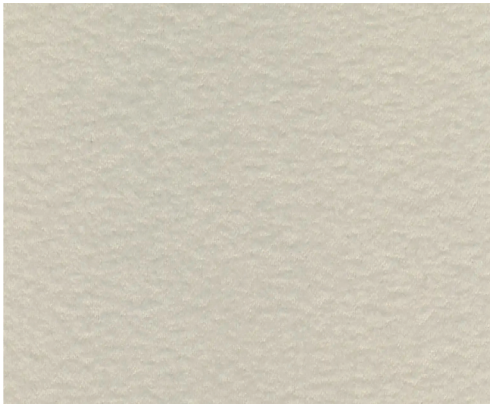

### KVADRAT - BARU

**MATERIAL:** 87% new wool 10% polyester  
3% polyamide  
*Width: 140cm - 55in*  
*Weight: 770g/ml - 24.84z/Lin.yd*

**DURABILITY:** 45.000 Martindale  
**ENVIRONMENT:** GREENGUARD GOLD, HPD,  
**EPD FIRE STANDARDS:** BS 5852 source 0  
/ 1. EN 1021-1 / 2 With flame retardant  
treatment: BS 5852 source 5.

**OUTDOOR**























## WEEK - END

STUDIO BRICHETZIEGLER

2017



 3012 BLUSH	 1016 YELLOW	 6019 PASTEL GREEN	 5002 BLUE	 7035 PEARL GREY
 8004 TERRACOTTA	 8000 GOLD	 6013 JADE GREEN	 5020 OCEAN BLUE	 DUNE
 2012 CORAL	 1015 IVORY	 6029 MINT GREEN	 5014 PIGEON BLUE	 9016 WHITE
 8012 BROWN RED	 1017 SAFFRON	 6007 GLASS GREEN	 5008 GREY BLUE	 9005 BLACK

## Chair, Bridge & Armchair

### Materials

Aluminium, matte grained Anti UV powder coating for outdoor use

### Colors

20 colors. RAL colors available with MOQ from our fine texture range (matt grained)

### Origin

China

### TECHNICAL SPECIFICATIONS

Compliant with EN 581-1 ; EN581 -2 for Contract Use and stackable up to 6 pieces for chairs and bridges, up to 4 pieces for armchairs.

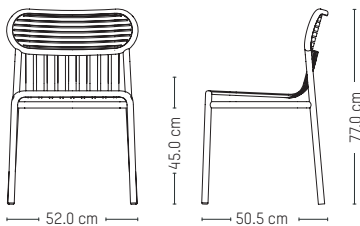

### Chair

**L:** 52.0 cm | 20.5 inches  
**W:** 50.0 cm | 19.7 inches  
**H:** 77.0 cm | 30.3 inches  
**H1:** 45.0 cm | 17.7 inches  
**Weight:** 3.0 kg | 6.6 lb

PACKAGING (x2):

**L:** 59.9.0 cm | 23.6 inches  
**W:** 60.1 cm | 23.7 inches  
**H:** 108.0 cm | 42.5 inches  
**Weight:** 11.0 kg | 24.3 lb

**Stackable**

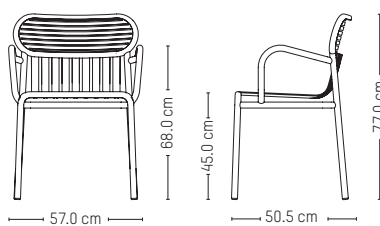

### Bridge

**L:** 57.0 cm | 22.4 inches  
**W:** 50.0 cm | 19.7 inches  
**H:** 77.0 cm | 30.3 inches  
**H1:** 45.0 cm | 17.7 inches  
**Weight:** 4.0 kg | 8.8 lb

PACKAGING (x2):

**L:** 59.9.0 cm | 23.6 inches  
**W:** 60.1 cm | 23.7 inches  
**H:** 108.0 cm | 42.5 inches  
**Weight:** 12.0 kg | 26.5 lb

**Stackable**

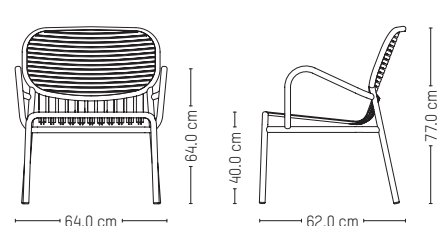

### Armchair

**L:** 64.0 cm | 25.2 inches  
**L:** 62.0 cm | 24.4 inches  
**H:** 77.0 cm | 30.3 inches (back)  
**H:** 40.0 cm | 15.7 inches (seat)  
**H:** 62.0 cm | 24.4 inches (armrests)  
**Weight:** 5.0 kg | 11.0 lb

PACKAGING (x2):

**L:** 72.0 cm | 28.3 inches  
**W:** 72.0 cm | 28.3 inches  
**H:** 87.0 cm | 34.3 inches  
**Weight:** 15.0 kg | 33.1 lb



















**Stackable**

## WEEK - END

STUDIO BRICHETZIEGLER

2019



 3012 BLUSH	 1016 YELLOW	 6019 PASTEL GREEN	 5002 BLUE	 7035 PEARL GREY
 8004 TERRACOTTA	 8000 GOLD	 6013 JADE GREEN	 5020 OCEAN BLUE	 DUNE
 2012 CORAL	 1015 IVORY	 6029 MINT GREEN	 5014 PIGEON BLUE	 9016 WHITE
 8012 BROWN RED	 1017 SAFFRON	 6007 GLASS GREEN	 5008 GREY BLUE	 9005 BLACK

## Sofa

-

### Materials

Aluminium, matte grained Anti UV powder coating for outdoor use

### Colors

20 colors. RAL colors available with MOQ from our fine texture range (matt grained)

### Origin

China

### TECHNICAL SPECIFICATIONS

Compliant with EN 581-1 ; EN581 -2 for Contract Use

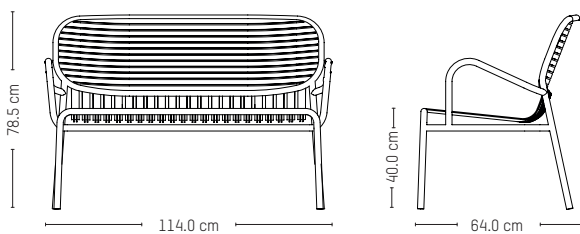

## 2 seater sofa

-

**L:** 113.5 cm | 44.7 inches  
**W:** 64.0 cm | 25.2 inches  
**H:** 78.5 cm | 30.5 inches (back)  
**H:** 40.0 cm | 15.7 inches (seat)  
**Weight:** 10.0 kg | 22.0 lb

### PACKAGING:

**L:** 118.0 cm | 46.5 inches  
**W:** 64.0 cm | 25.2 inches  
**H:** 83.0 cm | 32.7 inches  
**Weight:** 15.0 kg | 33.1 lb



















### Stackable

## WEEK - END

STUDIO BRICHETZIEGLER

2017



 3012 BLUSH	 1016 YELLOW	 6019 PASTEL GREEN	 5002 BLUE	 7035 PEARL GREY
 8004 TERRACOTTA	 8000 GOLD	 6013 JADE GREEN	 5020 OCEAN BLUE	 DUNE
 2012 CORAL	 1015 IVORY	 6029 MINT GREEN	 5014 PIGEON BLUE	 9016 WHITE
 8012 BROWN RED	 1017 SAFFRON	 6007 GLASS GREEN	 5008 GREY BLUE	 9005 BLACK

## Benches

### Materials

Aluminium, matte grained Anti UV powder coating for outdoor use

### Colors

20 colors. RAL colors available with MOQ from our fine texture range (matt grained)

### Origin

China

### TECHNICAL SPECIFICATIONS

Compliant with EN 581-1 ; EN581 -2 for Contract Use

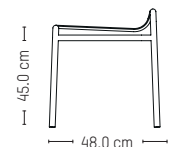
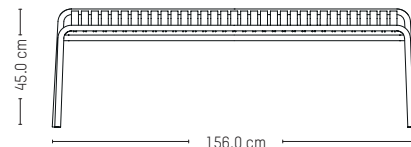
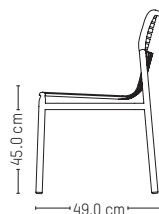
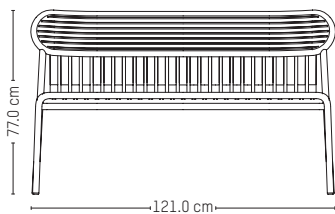

## Bench

**L:** 121.0 cm | 47.6 inches  
**W:** 49.0 cm | 19.3 inches  
**H:** 77.0 cm | 30.3 inches (back)  
**H:** 45.0 cm | 17.7 inches (seat)  
**Weight:** 9.0 kg | 19.8 lb

### PACKAGING:

**L:** 125.0 cm | 49.2 inches  
**W:** 54.0 cm | 21.3 inches  
**H:** 80.0 cm | 31.5 inches  
**Weight:** 13.0 kg | 28.7 lb

### Stackable

## Bench without back

**L:** 156.0 cm | 61.4 inches  
**W:** 48.0 cm | 18.9 inches  
**H:** 45.0 cm | 17. inches (seat)  
**Weight:** 8.0 kg | 17.6 lb

### PACKAGING:

**L:** 160.0 cm | 63.0 inches  
**W:** 55.0 cm | 21.7 inches  
**H:** 59.0 cm | 23.2 inches  
**Weight:** 12.0 kg | 26.5 lb



















### Stackable

## WEEK - END

STUDIO BRICHETZIEGLER

2017



 3012 BLUSH	 1016 YELLOW	 6019 PASTEL GREEN	 5002 BLUE	 7035 PEARL GREY
 8004 TERRACOTTA	 8000 GOLD	 6013 JADE GREEN	 5020 OCEAN BLUE	 DUNE
 2012 CORAL	 1015 IVORY	 6029 MINT GREEN	 5014 PIGEON BLUE	 9016 WHITE
 8012 BROWN RED	 1017 SAFFRON	 6007 GLASS GREEN	 5008 GREY BLUE	 9005 BLACK

## Stools

### Materials

Aluminium, matte grained Anti UV powder coating for outdoor use

### Colors

20 colors. RAL colors available with MOQ from our fine texture range (matt grained)

### Origin

China

### TECHNICAL SPECIFICATIONS

Compliant with EN 581-1 ; EN581 -2 for Contract Use and stackable up to 3 pieces.

79

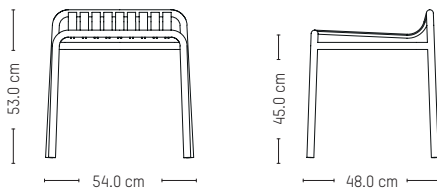

## Stool

**L:** 54.0 cm | 21.3 inches  
**W:** 48.0 cm | 18.9 inches  
**H:** 53.0 cm | 20.9 inches  
**H (seat):** 45.0 cm | 17.7 inches  
**Weight:** 3.0 kg | 6.6 lb

### PACKAGING:

**L:** 62.0 cm | 24.4 inches  
**W:** 54.0 cm | 21.3 inches  
**H:** 57.0 cm | 22.4 inches  
**Weight:** 5.0 kg | 11.0 lb

### Stackable

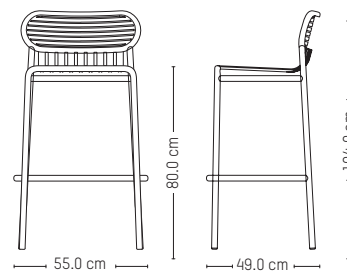

## Bar stool

**L:** 49.0 cm | 19.3 inches  
**W:** 55.0 cm | 21.7 inches  
**H:** 104.0 cm | 40.9 inches  
**H (seat):** 80.0 cm | 31.5 inches  
**Weight:** 4.0 kg | 8.8 lb

### PACKAGING:

**L:** 68.0 cm | 26.8 inches  
**W:** 60.0 cm | 23.6 inches  
**H:** 108.0 cm | 42.5 inches  
**Weight:** 8.0 kg | 17.6 lb

## WEEK - END

STUDIO BRICHETZIEGLER

2019



### Trolley

-

#### Materials

Aluminium, matte grained Anti UV powder coating for outdoor use

#### Colors

20 colors. RAL colors available with MOQ from our fine texture range (matt grained)

#### Origin

China

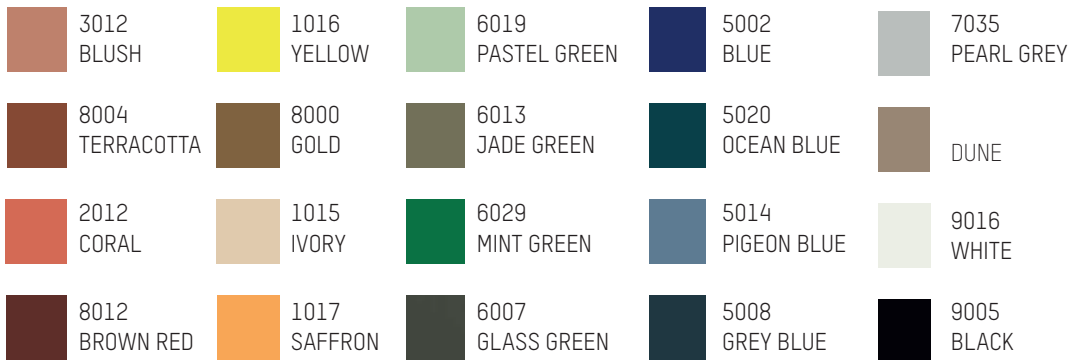

80

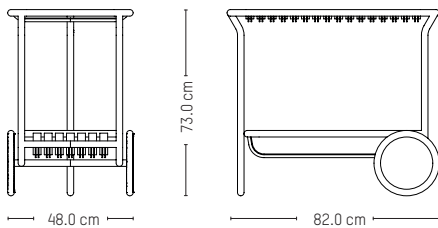

### Trolley

-

**W:** 48.0 cm | 18.9 inches

**L:** 82.0 cm | 32.3 inches

**H:** 73.0 cm | 28.7 inches

**Weight:** 8.0 kg | 17.6 lb

#### PACKAGING:

**L:** 86.0 cm | 33.9 inches

**W:** 52.0 cm | 20.5 inches

**H:** 78.0 cm | 30.7 inches

**Weight:** 10.0 kg | 22.0 lb



## WEEK - END

STUDIO BRICHETZIEGLER

2024



### Footstool & small side table

-

#### Materials





















Aluminium, matte grained Anti UV powder coating for outdoor use

#### Colors

20 colors. RAL colors available with MOQ from our fine texture range (matt grained)

#### Origin

China

 3012 BLUSH	 1016 YELLOW	 6019 PASTEL GREEN	 5002 BLUE	 7035 PEARL GREY
 8004 TERRACOTTA	 8000 GOLD	 6013 JADE GREEN	 5020 OCEAN BLUE	 DUNE
 2012 CORAL	 1015 IVORY	 6029 MINT GREEN	 5014 PIGEON BLUE	 9016 WHITE
 8012 BROWN RED	 1017 SAFFRON	 6007 GLASS GREEN	 5008 GREY BLUE	 9005 BLACK

81

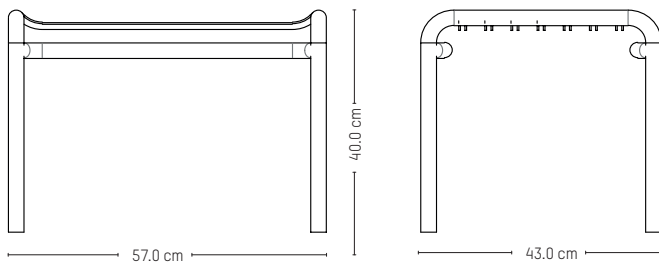

### Footstool & small side table

-

**W:** 43.0 cm | 16.9 inches

**L:** 57.0 cm | 22.4 inches

**H:** 40.0 cm | 15.7 inches

**Weight:** 23.0 kg | 51.1 lb

## WEEK-END

STUDIO BRICHETZIEGLER

2017



### Coffee tables

-

#### Materials





















Aluminium, matte grained Anti UV powder coating for outdoor use

#### Colors

20 colors. RAL colors available with MOQ from our fine texture range (matt grained)

#### Origin

China

 3012 BLUSH	 1016 YELLOW	 6019 PASTEL GREEN	 5002 BLUE	 7035 PEARL GREY
 8004 TERRACOTTA	 8000 GOLD	 6013 JADE GREEN	 5020 OCEAN BLUE	 DUNE
 2012 CORAL	 1015 IVORY	 6029 MINT GREEN	 5014 PIGEON BLUE	 9016 WHITE
 8012 BROWN RED	 1017 SAFFRON	 6007 GLASS GREEN	 5008 GREY BLUE	 9005 BLACK

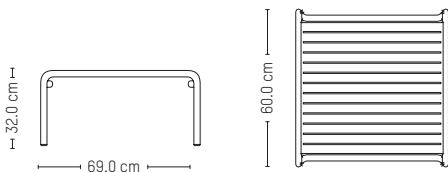

### Coffee table

-

**W:** 69.0 cm | 27.2 inches

**L:** 60.0 cm | 23.6 inches

**H:** 32.0 cm | 12.6 inches

**Weight:** 5.0 kg | 11.0 lb

#### PACKAGING:

**L:** 78.0 cm | 30.7 inches

**W:** 73.0 cm | 28.7 inches

**H:** 38.0 cm | 15.0 inches

**Weight:** 7.0 kg | 15.4 lb

### Long coffee table

-

**W:** 51.0 cm | 20.1 inches

**L:** 127.0 cm | 50.0 inches

**H:** 41.0 cm | 16.1 inches

**Weight:** 7.0 kg | 15.4 lb

#### PACKAGING:

**L:** 130.0 cm | 51.1 inches

**W:** 58.0 cm | 23.2 inches

**H:** 45.0 cm | 17.7 inches

**Weight:** 10.0 kg | 22.0 lb

# WEEK - END

STUDIO BRICHETZIEGLER

2017



## Dining tables (with slatted top)

### Materials





















Aluminium, matte grained Anti UV powder coating for outdoor use

### Colors

20 colors. RAL colors available with MOQ from our fine texture range (matt grained)

### Origin

China

 3012 BLUSH	 1016 YELLOW	 6019 PASTEL GREEN	 5002 BLUE	 7035 PEARL GREY
 8004 TERRACOTTA	 8000 GOLD	 6013 JADE GREEN	 5020 OCEAN BLUE	 DUNE
 2012 CORAL	 1015 IVORY	 6029 MINT GREEN	 5014 PIGEON BLUE	 9016 WHITE
 8012 BROWN RED	 1017 SAFFRON	 6007 GLASS GREEN	 5008 GREY BLUE	 9005 BLACK

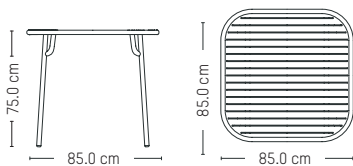

### Square table

**L:** 85.0 cm | 33.5 inches  
**W:** 85.0 cm | 33.5 inches  
**H:** 75.0 cm | 29.5 inches  
**Weight:** 11.4 kg | 25.1 lb

#### PACKAGING:

##### packaging tabletop

**L:** 88.0 cm | 34.6 inches  
**W:** 87.0 cm | 34.3 inches  
**H:** 7.0 cm | 2.8 inches  
**Weight:** 11.0 kg | 24.3 lb

##### packaging legs (x2)

**L:** 20.0 cm | 7.9 inches  
**W:** 20.0 cm | 7.9 inches  
**H:** 82.0 cm | 32.3 inches  
**Weight:** 2.3 kg | 5.1 lb

#### Assembly

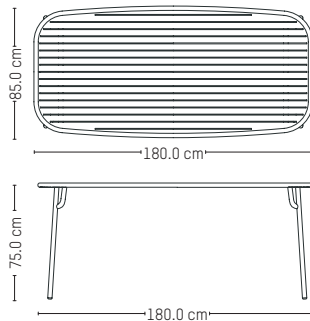

### Rectangular table medium

**W:** 85.0 cm | 33.5 inches  
**L:** 180.0 cm | 70.9 inches  
**H:** 75.0 cm | 29.5 inches  
**Weight:** 20.4 kg | 45.0 lb

#### PACKAGING:

##### packaging table top

**L:** 186.0 cm | 73.2 inches  
**W:** 95.0 cm | 37.4 inches  
**H:** 11.0 cm | 4.3 inches  
**Weight:** 22.0 kg | 48.5 lb

##### packaging legs (x2)

**L:** 20.0 cm | 7.9 inches  
**W:** 20.0 cm | 7.9 inches  
**H:** 82.0 cm | 32.3 inches  
**Weight:** 2.3 kg | 5.1 lb

#### Assembly

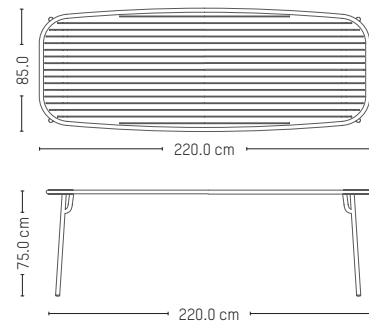

### Rectangular table large

**W:** 85.0 cm | 33.5 inches  
**L:** 220.0 cm | 86.6 inches  
**H:** 75.0 cm | 29.5 inches  
**Weight:** 26.4 kg | 58.2 lb

#### PACKAGING:

##### packaging table top

**L:** 226.0 cm | 89.0 inches  
**W:** 95.0 cm | 37.4 inches  
**H:** 11.0 cm | 4.3 inches  
**Weight:** 28.0 kg | 61.7 lb

##### packaging legs (x2)

**L:** 20.0 cm | 7.9 inches  
**W:** 20.0 cm | 7.9 inches  
**H:** 82.0 cm | 32.3 inches  
**Weight:** 2.3 kg | 5.1 lb

#### Assembly



**Dining tables (with plain top)**

**Materials**

Aluminium, matte grained Anti UV powder coating for outdoor use

**Colors**

20 colors. RAL colors available with MOQ from our fine texture range (matt grained)

**Origin**

China

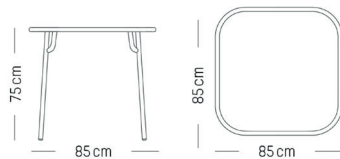
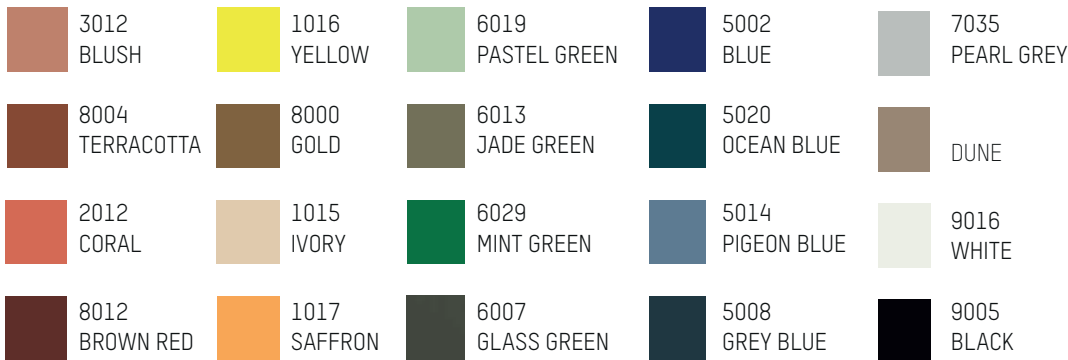

**Square table**

**L:** 85.0 cm | 33.5 inches  
**W:** 85.0 cm | 33.5 inches  
**H:** 75.0 cm | 29.5 inches  
**Weight:** 13.3 kg | 29.3 lb

**PACKAGING:**

**packaging tabletop**  
**L:** 86.0 cm | 33.9 inches  
**W:** 86.0 cm | 33.9 inches  
**H:** 5.0 cm | 2.0 inches  
**Weight:** 10.0 kg | 22.0 lb

**packaging legs (x2)**  
**L:** 20.0 cm | 7.9 inches  
**W:** 20.0 cm | 7.9 inches  
**H:** 82.0 cm | 32.3 inches  
**Weight:** 2.3 kg | 5.1 lb

**Assembly**

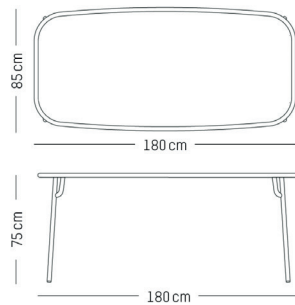

**Rectangular table medium**

**W:** 85.0 cm | 33.5 inches  
**L:** 180.0 cm | 70.9 inches  
**H:** 75.0 cm | 29.5 inches  
**Weight:** 23.2 kg | 51.1 lb

**PACKAGING:**

**packaging table top**  
**L:** 182.0 cm | 71.7 inches  
**W:** 88.0 cm | 34.6 inches  
**H:** 5.0 cm | 2.0 inches  
**Weight:** 22.0 kg | 48.5 lb

**packaging legs (x2)**  
**L:** 20.0 cm | 7.9 inches  
**W:** 20.0 cm | 7.9 inches  
**H:** 82.0 cm | 32.3 inches  
**Weight:** 2.3 kg | 5.1 lb

**Assembly**

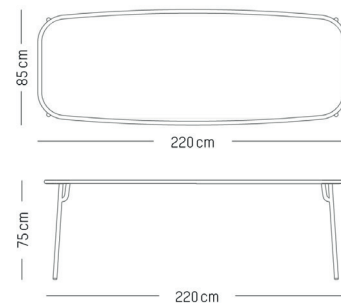

**Rectangular table large**

**W:** 85.0 cm | 33.5 inches  
**L:** 220.0 cm | 86.6 inches  
**H:** 75.0 cm | 29.5 inches  
**Weight:** 27.7 kg | 61.1 lb

**PACKAGING:**

**packaging table top**  
**L:** 222.0 cm | 87.4 inches  
**W:** 88.0 cm | 34.6 inches  
**H:** 5.0 cm | 2.0 inches  
**Weight:** 27 kg | 59.5 lb

**packaging legs (x2)**  
**L:** 20.0 cm | 7.9 inches  
**W:** 20.0 cm | 7.9 inches  
**H:** 82.0 cm | 32.3 inches  
**Weight:** 2.3 kg | 5.1 lb



















**Assembly**

## WEEK - END

STUDIO BRICHETZIEGLER

2019



 3012 BLUSH	 1016 YELLOW	 6019 PASTEL GREEN	 5002 BLUE	 7035 PEARL GREY
 8004 TERRACOTTA	 8000 GOLD	 6013 JADE GREEN	 5020 OCEAN BLUE	 DUNE
 2012 CORAL	 1015 IVORY	 6029 MINT GREEN	 5014 PIGEON BLUE	 9016 WHITE
 8012 BROWN RED	 1017 SAFFRON	 6007 GLASS GREEN	 5008 GREY BLUE	 9005 BLACK

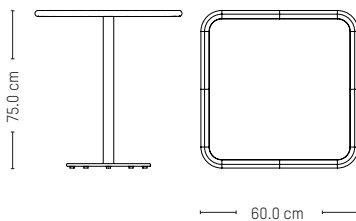

### Square bistro table

**L:** 60.0 cm | 23.6 inches  
**W:** 60.0 cm | 23.6 inches  
**H:** 75.0 cm | 29.5 inches  
**Weight:** 11.0 kg | 24.3 lb

PACKAGING:

**L:** 117.0 cm | 46.1 inches  
**W:** 80.0 cm | 31.5 inches  
**H:** 8.0 cm | 3.1 inches  
**Weight:** 13.0 kg | 28.7 lb

**Assembly**

### Bistro tables

-

**Materials**

Aluminium, matte grained Anti UV powder coating for outdoor use

**Colors**

20 colors. RAL colors available with MOQ from our fine texture range (matt grained)

**Origin**

China

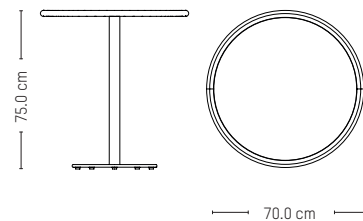

### Round bistro table

-

**Ø:** 70.0 cm | 27.6 inches  
**H:** 75.0 cm | 29.5 inches  
**Weight:** 10.0 kg | 22.0 lb

PACKAGING:

**L:** 117.0 cm | 46.1 inches  
**W:** 80.0 cm | 31.5 inches  
**H:** 8.0 cm | 3.1 inches  
**Weight:** 13.0 kg | 28.7 lb





















**Assembly**

## WEEK - END

STUDIO BRICHETZIEGLER

2019



 3012 BLUSH	 1016 YELLOW	 6019 PASTEL GREEN	 5002 BLUE	 7035 PEARL GREY
 8004 TERRACOTTA	 8000 GOLD	 6013 JADE GREEN	 5020 OCEAN BLUE	 DUNE
 2012 CORAL	 1015 IVORY	 6029 MINT GREEN	 5014 PIGEON BLUE	 9016 WHITE
 8012 BROWN RED	 1017 SAFFRON	 6007 GLASS GREEN	 5008 GREY BLUE	 9005 BLACK

### High tables

-

#### Materials

Aluminium, matte grained Anti UV powder coating for outdoor use

#### Colors

20 colors. RAL colors available with MOQ from our fine texture range (matt grained)

#### Origin

China

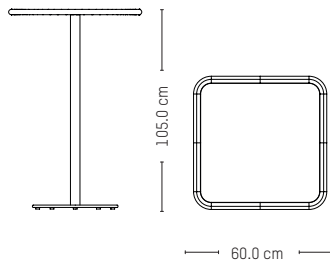

### High table square

-

**L:** 60.0 cm | 23.6 inches  
**W:** 60.0 cm | 23.6 inches  
**H:** 105.0 cm | 41.3 inches  
**Weight:** 13.0 kg | 28.7 lb

#### PACKAGING:

**L:** 117.0 cm | 46.1 inches  
**W:** 80.0 cm | 31.5 inches  
**H:** 8.0 cm | 3.1 inches  
**Weight:** 15.0 kg | 33.1 lb

#### Assembly

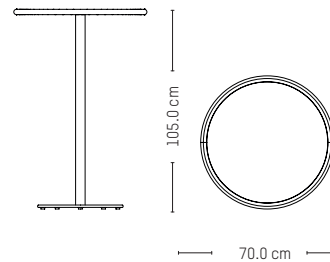

### High table round

-

**Ø:** 70.0 cm | 27.6 inches  
**L:** 70.0 cm | 23.7 inches  
**H:** 105.0 cm | 41.3 inches  
**Weight:** 12.0 kg | 26.5 lb

#### PACKAGING:

**L:** 117.0 cm | 46.1 inches  
**W:** 80.0 cm | 31.5 inches  
**H:** 8.0 cm | 3.1 inches  
**Weight:** 15.0 kg | 33.1 lb

#### Assembly

## WEEK - END

STUDIO BRICHETZIEGLER

2019

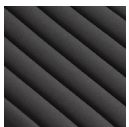

Anthracite



Pearl grey

### Cushions (available while stock last)

-

#### Materials

Cover in polyester, foam in polyurethane

#### Colors

Anthracite, Pearl grey

#### Origin

France

#### TECHNICAL SPECIFICATIONS

Dryfeel foam

Suitable for outdoor use.

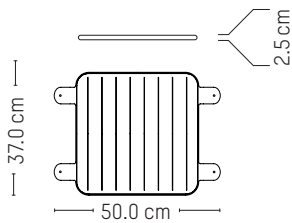

### Small

-

**L:** 50.0 cm | 19.7 inches

**W:** 37.0 cm | 14.6 inches

**H:** 2.5 cm | 1.0 inch

**Weight:** 0.4 kg | 0.9 lb

PACKAGING:

**L:** 53.0 cm | 20.9 inches

**W:** 53.0 cm | 20.9 inches

**Weight:** 0.6 kg | 1.3 lb

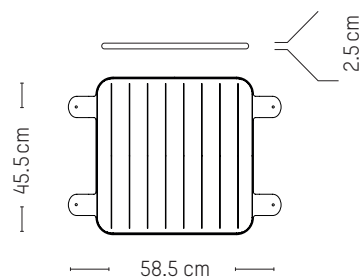

### Large

-

**L:** 58.5 cm | 23.0 inches

**W:** 45.5 cm | 17.5 inches

**H:** 2.5 cm | 1.0 inch

**Weight:** 0.4 kg | 0.9 lb

PACKAGING:

**L:** 60.0 cm | 23.6 inches

**W:** 53.0 cm | 20.9 inches

**Weight:** 0.6 kg | 1.3 lb

**DECORATION**





# BUBBLE

VAULOT & DYÈVRE

2013



Grey brown

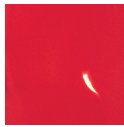

Vermilion



Lime

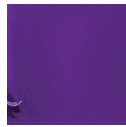

Purple

## Hooks

-

### Materials

Hook in blown glass, Fixing system in steel

### Colors

Grey brown, Vermilion, Lime, Purple

### Origin

Europe

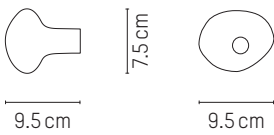

## Small

-

**H:** 9.5 cm | 3.7 inches  
**W:** 7.5 cm | 3.0 inches  
**D:** 9.5 cm | 3.7 inches  
**Weight:** 0.2 kg | 0.4 lb

### PACKAGING:

**H:** 22.5 cm | 8.8 inches  
**W:** 16.0 cm | 6.2 inches  
**L:** 16.5 cm | 6.4 inches  
**Weight:** 0.4 kg | 0.9 lb

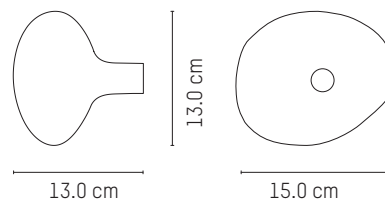

## Large

-

**H:** 13.0 cm | 5.1 inches  
**W:** 15.0 cm | 5.9 inches  
**D:** 13.0 cm | 5.1 inches  
**Weight:** 0.4 kg | 0.9 lb

### PACKAGING:

**H:** 26.0 cm | 10.1 inches  
**W:** 19.0 cm | 7.4 inches  
**L:** 24.0 cm | 9.4 inches  
**Weight:** 0.8 kg | 1.8 lb

# KLUMP

HENRIK ØDEGAARD

2023



Brown



Green



White

## Hooks

-

Material

Ceramic

Colors

White, brown, green

Origin

Portugal

SET 1: FORM 1 & 2 IN WHITE

SET 2: FORM 3 & 4 IN GREEN

SET 3: FORM 5 & 6 IN BROWN

SET 4: ALL FORMS IN WHITE

SET 5: ALL FORMS IN GREEN

SET 6: ALL FORMS IN BROWN

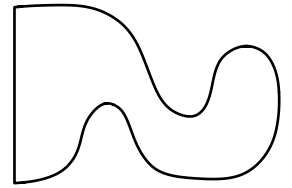
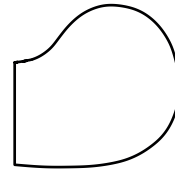
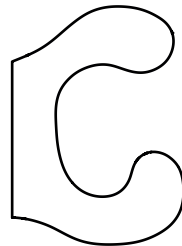
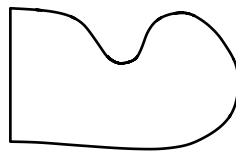
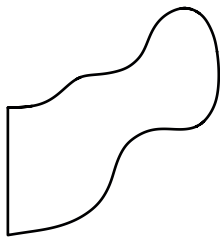
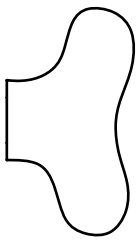

1

-

**L:** 11.0 cm | 4.3 inches  
**W:** 3.0 cm | 1.2 inches  
**D:** 19.0 cm | 7.5 inches  
**Weight:** 0.3 kg | 0.7 lbs

**PARCEL LOGISTICS :**

38.5 x 21.5 x 6.0 cm  
0.8 kg  
15.2 x 8.5 x 2.4 inches  
1.8 lbs

2

-

**L:** 13.0 cm | 5.1 inches  
**W:** 3.0 cm | 1.2 inches  
**D:** 15.0 cm | 5.9 inches  
**Weight:** 0.4 kg | 0.9 lbs

**PARCEL LOGISTICS :**

38.5 x 21.5 x 6.0 cm  
0.8 kg  
15.2 x 8.5 x 2.4 inches  
1.8 lbs

3

-

**L:** 13.0 cm | 5.1 inches  
**W:** 3.0 cm | 1.2 inches  
**D:** 7.5 cm | 3.0 inches  
**Weight:** 0.1 kg | 0.2 lbs

**PARCEL LOGISTICS :**

38.5 x 21.5 x 6.0 cm  
0.4 kg  
15.2 x 8.5 x 2.4 inches  
0.9 lbs

4

-

**L:** 13.0 cm | 5.1 inches  
**W:** 3.0 cm | 1.2 inches  
**D:** 18.5 cm | 7.3 inches  
**Weight:** 0.2 kg | 0.4 lb

**PARCEL LOGISTICS :**

38.5 x 21.5 x 6.0 cm  
0.4 kg  
15.2 x 8.5 x 2.4 inches  
0.9 lbs

5

-

**L:** 12.0 cm | 4.7 inches  
**W:** 3.0 cm | 1.2 inches  
**D:** 12.0 cm | 4.7 inches  
**Weight:** 0.2 kg | 0.4 lb

**PARCEL LOGISTICS :**

38.5 x 21.5 x 6.0 cm  
0.7 kg  
15.2 x 8.5 x 2.4 inches  
1.5 lbs

6

-

**L:** 19.5 cm | 7.7 inches  
**W:** 3.0 cm | 1.2 inches  
**D:** 13.0 cm | 5.1 inches  
**Weight:** 0.4 kg | 0.9 lbs

**PARCEL LOGISTICS :**

38.5 x 21.5 x 6.0 cm  
0.7 kg  
15.2 x 8.5 x 2.4 inches  
1.5 lbs

# SMALL STRIPES

CAROLE BAIJINGS

2023

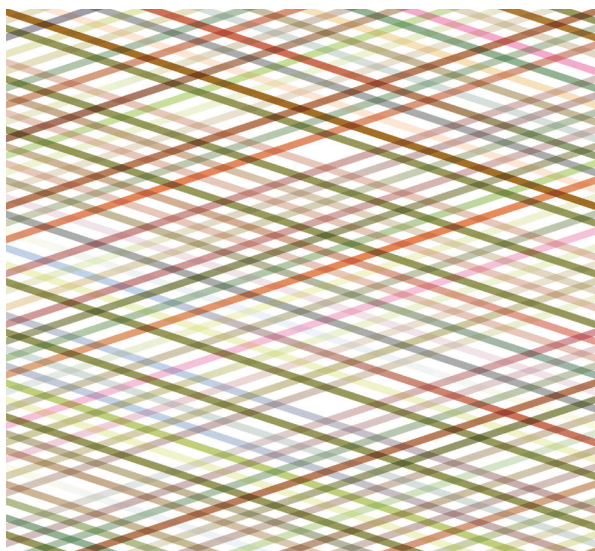

Spring

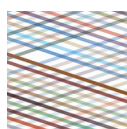

Summer

## Wallpaper

-

### Materials

Non-woven wallpaper 1956/M2

### Colors

Spring Vegetables, Summer Vegetables

### Origin

France

## TECHNICAL SPECIFICATIONS

Certification: Flame retardant C-s1.d0

 Apply Paste to the wall

 Dry peelable

 Light-proof

 Washable



**L:** 1000.0 cm | 393.7 inches

**W:** 50.0 cm | 19.7 inches

**Weight:** 1.8 kg | 4.0 lb

### PACKAGING:

52x11x11cm | 20.4x4.3x4.3 inches

**Weight:** 1.9 kg | 4.2 lb

# LARGE STRIPES

CAROLE BAIJINGS

2023

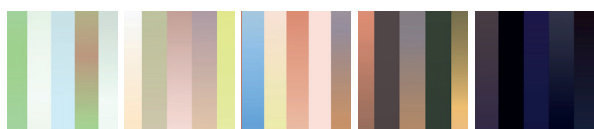

Morning    Midday    Afternoon    Evening    Nightfall

## Wallpaper

-

### Materials

Non-woven wallpaper 1956/M2

### Colors

Morning, Midday, Afternoon, Evening, Nightfall

### Origin

France

## TECHNICAL SPECIFICATIONS

Certification: Flame retardant C-s1.d0



Apply Paste to the wall



Dry peelable



Light-proof



Washable



**L:** 1000.0 cm | 393.7 inches

**W:** 50.0 cm | 19.7 inches

**Weight:** 1.8 kg | 4.0 lb

### PACKAGING:

52x11x11cm | 20.4x4.3x4.3 inches

**Weight:** 1.9 kg | 4.2 lb

# PANORAMA

CAROLE BAIJINGS

2023

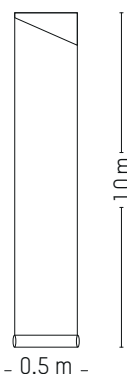
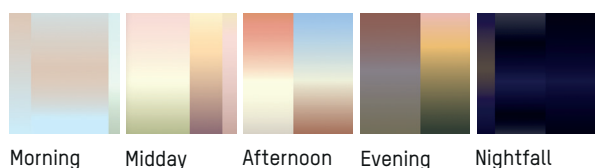
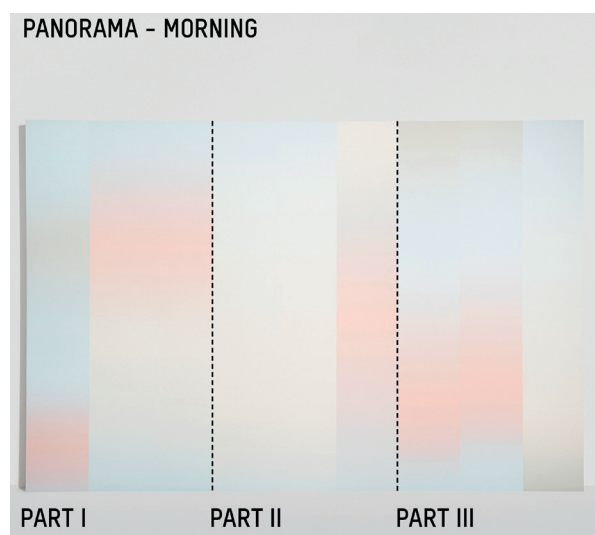

## Wallpaper panorama in 3 parts

### Materials

Non-woven wallpaper 1956/M2

### Colors

Morning, Midday, Afternoon, Evening, Nightfall

### Origin

France

### TECHNICAL SPECIFICATIONS

Certification: Flame retardant C-s1.d0

Apply Paste to the wall

Dry peelable

Light-proof

Washable

This mural wallpaper is created as a complete design 450 cm wide and 320 cm high. It is supplied on 3 rolls (Part 1, Part 2, Part 3) 50 cm wide by 10 m long, each roll comprising three 320cm drops to be hung next to each other. Total coverage 14.4m<sup>2</sup>. Can be joined in multiples according to your wall width and trimmed in the height if required.

For your convenience, each roll (Part 1, Part 2, Part 3) can be purchased separately.

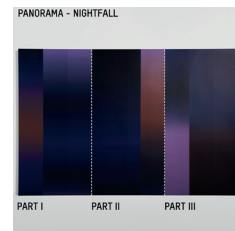
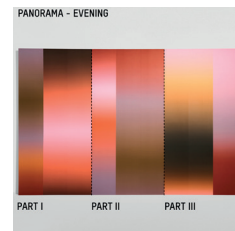
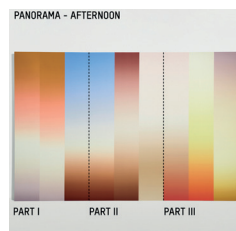
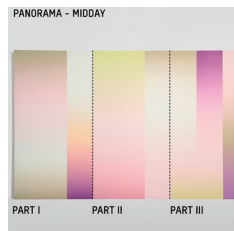
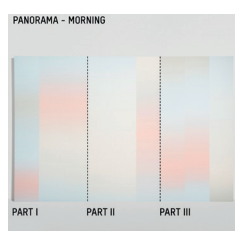

**L:** 1000.0 cm | 393.7 inches

**W:** 50.0 cm | 19.7 inches

**Weight:** 1.8 kg | 4.0 lb

### PACKAGING:

52x11x11cm | 20.4x4.3x4.3 inches

**Weight:** 1.9 kg | 4.2 lb

# GAUFRETTE

LES CRAFTIES

2023

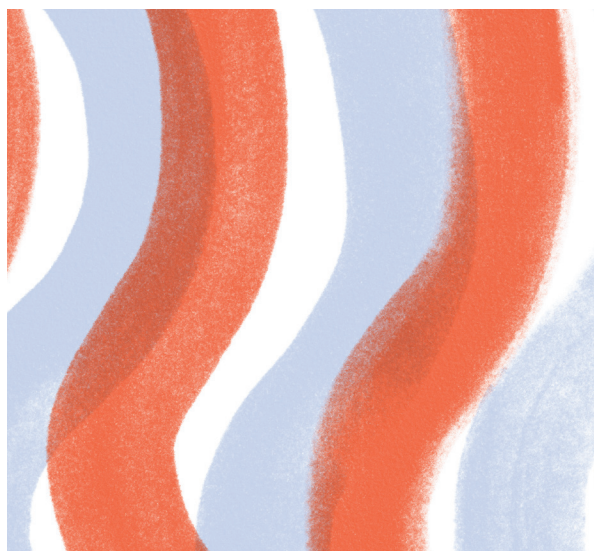

Pink

Green

Orange

Red

Blue

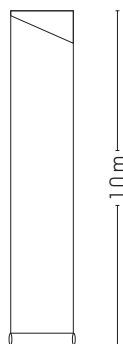

- 0.5 m -

**L:** 1000.0 cm | 393.7 inches

**W:** 50.0 cm | 19.7 inches

**Weight:** 1.8 kg | 4.0 lb

PACKAGING:

52x11x11cm | 20.4x4.3x4.3 inches

**Weight:** 1.9 kg | 4.2 lb

## Wallpaper

-

### Materials

Non-woven wallpaper 1956/M2

### Colors

Morning, Midday, Afternoon, Evening, Nightfall

### Origin

France

## TECHNICAL SPECIFICATIONS

Certification: Flame retardant C-s1.d0



Apply Paste to the wall



Dry peelable



Light-proof



Washable

# CROISILLON

LES CRAFTIES

2023

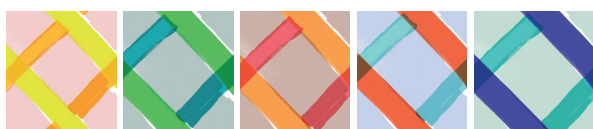

Pink

Green

Orange

Red

Blue



**L:** 1000.0 cm | 393.7 inches

**W:** 50.0 cm | 19.7 inches

**Weight:** 1.8 kg | 4.0 lb

PACKAGING:

52x11x11cm | 20.4x4.3x4.3 inches

**Weight:** 1.9 kg | 4.2 lb

## Wallpaper

-

### Materials

Non-woven wallpaper 1956/M2

### Colors

Morning, Midday, Afternoon, Evening, Nightfall

### Origin

France

## TECHNICAL SPECIFICATIONS

Certification: Flame retardant C-s1.d0

 Apply Paste to the wall

 Dry peelable

 Light-proof

 Washable



# MOSAÏQUE

LES CRAFTIES

2023



Pink

Green

Orange

Red

Blue

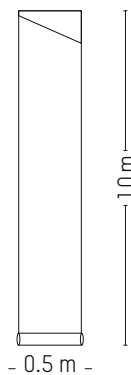

**L:** 1000.0 cm | 393.7 inches

**W:** 50.0 cm | 19.7 inches

**Weight:** 1.8 kg | 4.0 lb

PACKAGING:

52x11x11cm | 20.4x4.3x4.3 inches

**Weight:** 1.9 kg | 4.2 lb

## Wallpaper

-

Materials

Non-woven wallpaper 1956/M2

Colors

Morning, Midday, Afternoon, Evening, Nightfall

Origin

France

## TECHNICAL SPECIFICATIONS

Certification: Flame retardant C-s1.d0

 Apply Paste to the wall

 Dry peelable

 Light-proof

 Washable

# DONUT

PIA CHEVALIER

2022

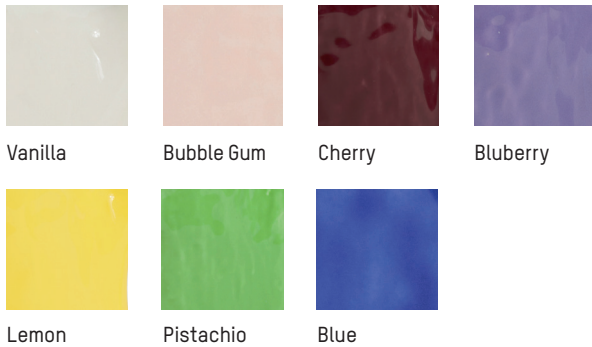

## Tableware

### Materials

Earthenware, white clay and enamel.

### Colors

Espresso cup and mug M: Vanilla, Bubble Gum, Cherry, Blueberry, Lemon and Pistachio

Mug L: Vanilla, bubble gum, Pistachio & Lemon

### Origin

Portugal

### TECHNICAL SPECIFICATIONS

Food compliance European tests: Lead and cadmium tests

- (EC) 1935/2004/EC

- (EC) No 2023/2006

Food compliance American tests: Lead and cadmium tests

- FDA (Food and Drug administration) Title 21 Code of Federal

Regulations (CFR, 2011 Edition)

FOOD SAFE



99

RF

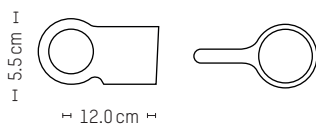

### Espresso cup (set of 2 pcs)

**Ø:** 6.0 cm | 2.4 inches

**H:** 5.5 cm | 2.2 inches

**Weight:** 0.2 kg | 0.4 lb

PACKAGING (Cash&Carry = 1 set)

**L:** 17.0 cm | 6.7 inches

**W:** 15.0 cm | 5.5 inches

**H:** 9.0 cm | 3.5 inches

**Weight:** 0.4 kg | 0.9 lb

Master Pack (2 cash&carry)

**L:** 31.0 cm | 12.2 inches

**W:** 19.0 cm | 7.5 inches

**H:** 10.0 cm | 4.0 inches

**Weight:** 1.0 kg | 2.2 lb

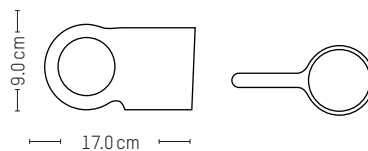

### Mug M

**Ø:** 8.0 cm | 3.1 inches

**H:** 9.0 cm | 3.5 inches

**Weight:** 0.3 kg | 0.7 lb

PACKAGING (Cash&Carry = 1 M)

**L:** 22.0 cm | 8.7 inches

**W:** 12.0 cm | 4.7 inches

**H:** 13.0 cm | 5.1 inches

**Weight:** 0.4 kg | 0.9 lb

Master Pack (2 cash&carry)

**L:** 25.0 cm | 9.8 inches

**W:** 25.0 cm | 9.8 inches

**H:** 14.0 cm | 5.5 inches

**Weight:** 1.0 kg | 2.2 lb

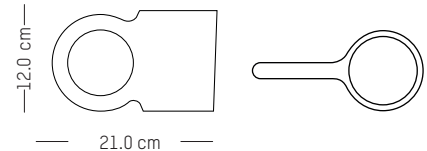

### Mug L

**Ø:** 9.0 cm | 3.5 inches

**H:** 12.0 cm | 4.7 inches

**Weight:** 0.5 kg | 1.1 lb

PACKAGING Cash&Carry = 1 L)

**L:** 26.0 cm | 10.2 inches

**W:** 13.0 cm | 5.1 inches

**H:** 15.0 cm | 5.9 inches

**Weight:** 0.6 kg | 1.3 lb

Master Pack (2 cash&carry)

**L:** 28.0 cm | 11.0 inches

**W:** 27.0 cm | 10.6 inches

**H:** 16.0 cm | 6.3 inches

**Weight:** 1.4 kg | 3.1 lb

# Petite Friture

## **PETITE FRITURE**

**45 TER RUE DE LA REVOLUTION 93100 MONTREUIL**  
T + 33 (0)1 44 54 13 95

SAS au capital de 85 778€ - R.C.S Paris 513 649 343

-  
*[www.petitefriture.com](http://www.petitefriture.com)*